

ETSI TS 126 132 V8.3.0 (2015-01)



**Universal Mobile Telecommunications System (UMTS);
LTE;
Speech and video telephony terminal acoustic test
specification
(3GPP TS 26.132 version 8.3.0 Release 8)**



Reference

RTS/TSGS-0426132v830

Keywords

LTE,UMTS

ETSI

650 Route des Lucioles
F-06921 Sophia Antipolis Cedex - FRANCE

Tel.: +33 4 92 94 42 00 Fax: +33 4 93 65 47 16

Siret N° 348 623 562 00017 - NAF 742 C
Association à but non lucratif enregistrée à la
Sous-Préfecture de Grasse (06) N° 7803/88

Important notice

The present document can be downloaded from:

<http://www.etsi.org>

The present document may be made available in electronic versions and/or in print. The content of any electronic and/or print versions of the present document shall not be modified without the prior written authorization of ETSI. In case of any existing or perceived difference in contents between such versions and/or in print, the only prevailing document is the print of the Portable Document Format (PDF) version kept on a specific network drive within ETSI Secretariat.

Users of the present document should be aware that the document may be subject to revision or change of status. Information on the current status of this and other ETSI documents is available at

<http://portal.etsi.org/tb/status/status.asp>

If you find errors in the present document, please send your comment to one of the following services:

http://portal.etsi.org/chaicor/ETSI_support.asp

Copyright Notification

No part may be reproduced or utilized in any form or by any means, electronic or mechanical, including photocopying and microfilm except as authorized by written permission of ETSI.

The content of the PDF version shall not be modified without the written authorization of ETSI.
The copyright and the foregoing restriction extend to reproduction in all media.

© European Telecommunications Standards Institute 2015.

All rights reserved.

DECT™, **PLUGTESTS™**, **UMTS™** and the ETSI logo are Trade Marks of ETSI registered for the benefit of its Members. **3GPP™** and **LTE™** are Trade Marks of ETSI registered for the benefit of its Members and of the 3GPP Organizational Partners.
GSM® and the GSM logo are Trade Marks registered and owned by the GSM Association.

Intellectual Property Rights

IPRs essential or potentially essential to the present document may have been declared to ETSI. The information pertaining to these essential IPRs, if any, is publicly available for **ETSI members and non-members**, and can be found in ETSI SR 000 314: *"Intellectual Property Rights (IPRs); Essential, or potentially Essential, IPRs notified to ETSI in respect of ETSI standards"*, which is available from the ETSI Secretariat. Latest updates are available on the ETSI Web server (<http://ipr.etsi.org>).

Pursuant to the ETSI IPR Policy, no investigation, including IPR searches, has been carried out by ETSI. No guarantee can be given as to the existence of other IPRs not referenced in ETSI SR 000 314 (or the updates on the ETSI Web server) which are, or may be, or may become, essential to the present document.

Foreword

This Technical Specification (TS) has been produced by ETSI 3rd Generation Partnership Project (3GPP).

The present document may refer to technical specifications or reports using their 3GPP identities, UMTS identities or GSM identities. These should be interpreted as being references to the corresponding ETSI deliverables.

The cross reference between GSM, UMTS, 3GPP and ETSI identities can be found under <http://webapp.etsi.org/key/queryform.asp>.

Modal verbs terminology

In the present document "**shall**", "**shall not**", "**should**", "**should not**", "**may**", "**may not**", "**need**", "**need not**", "**will**", "**will not**", "**can**" and "**cannot**" are to be interpreted as described in clause 3.2 of the [ETSI Drafting Rules](#) (Verbal forms for the expression of provisions).

"**must**" and "**must not**" are **NOT** allowed in ETSI deliverables except when used in direct citation.

Contents

| | |
|--|----|
| Intellectual Property Rights | 2 |
| Foreword..... | 2 |
| Modal verbs terminology..... | 2 |
| Foreword..... | 6 |
| Introduction | 6 |
| 1 Scope | 7 |
| 2 References | 7 |
| 3 Definitions, symbols and abbreviations | 8 |
| 3.1 Definitions | 8 |
| 3.2 Abbreviations | 8 |
| 4 Interfaces | 9 |
| 5 Test configurations | 9 |
| 5.1 Setup for terminals | 9 |
| 5.1.1 Setup for handset terminals..... | 10 |
| 5.1.2 Setup for headset terminals..... | 10 |
| 5.1.3 Setup for hands-free terminals | 11 |
| 5.1.3.1 Vehicle mounted hands-free..... | 11 |
| 5.1.3.2 Desktop mounted hands-free..... | 12 |
| 5.1.3.3 Handheld hands-free | 12 |
| 5.1.4 Position and calibration of HATS..... | 14 |
| 5.2 Setup of the electrical interfaces..... | 14 |
| 5.2.1 Codec approach and specification..... | 14 |
| 5.2.2 Direct digital processing approach..... | 15 |
| 5.3 Accuracy of test equipment | 15 |
| 5.4 Test signals..... | 16 |
| 5.5 Additional setup for wideband testing..... | 16 |
| 5.5.1 Setup for handsets and headsets..... | 16 |
| 5.5.2 Additional test setup for handsfree function with softphone UE | 17 |
| 5.5.2.1 Softphone including speakers and microphone | 18 |
| 5.5.2.2 Softphone with separate speakers..... | 20 |
| 6 Test conditions | 23 |
| 6.1 Environmental conditions..... | 23 |
| 6.1.1 Handset and headset terminals..... | 23 |
| 6.1.2 Hands-free terminals..... | 23 |
| 6.2 System Simulator conditions..... | 24 |
| 7 Narrow-band telephony transmission performance test methods..... | 24 |
| 7.1 Applicability..... | 24 |
| 7.2 Overall loss/loudness ratings..... | 24 |
| 7.2.1 General..... | 24 |
| 7.2.2 Connections with handset UE..... | 25 |
| 7.2.2.1 Sending Loudness Rating (SLR)..... | 25 |
| 7.2.2.2 Receiving Loudness Rating (RLR) | 25 |
| 7.2.3 Connections with Vehicle Mounted & Desk-Top hands-free UE..... | 25 |
| 7.2.3.1 Sending Loudness Rating (SLR)..... | 25 |
| 7.2.3.2 Receiving Loudness Rating (RLR) | 26 |
| 7.2.4 Connections with Handheld hands-free UE..... | 26 |
| 7.2.4.1 Sending Loudness Rating (SLR)..... | 26 |
| 7.2.4.2 Receiving Loudness Rating (RLR) | 27 |
| 7.2.5 Connections with headset UE | 27 |
| 7.3 Idle channel noise (handset and headset UE) | 27 |

| | | |
|---------|---|----|
| 7.3.1 | Sending | 27 |
| 7.3.2 | Receiving | 27 |
| 7.4 | Sensitivity/frequency characteristics | 28 |
| 7.4.1 | Handset UE sending..... | 28 |
| 7.4.2 | Handset UE receiving | 28 |
| 7.4.3 | Vehicle Mounted & Desk-Top hands-free UE sending | 28 |
| 7.4.4 | Vehicle Mounted & Desk-Top hands-free UE receiving..... | 29 |
| 7.4.5 | Hand-Held hands-free UE sending | 29 |
| 7.4.6 | Hand-Held hands-free UE receiving..... | 29 |
| 7.5 | Sidetone characteristics | 29 |
| 7.5.1 | Connections with Handset UE..... | 29 |
| 7.5.1.1 | Connections with Handset UE – LRGP method | 30 |
| 7.5.1.2 | Connections with Handset UE – HATS method | 30 |
| 7.5.2 | Headset UE | 30 |
| 7.5.3 | Hands-free UE (all categories)..... | 30 |
| 7.6 | Stability loss | 30 |
| 7.7 | Acoustic echo control..... | 31 |
| 7.7.1 | General..... | 31 |
| 7.7.2 | Acoustic echo control in a Hands-free UE..... | 31 |
| 7.7.3 | Acoustic echo control in a handset UE | 32 |
| 7.7.4 | Acoustic echo control in a headset UE | 32 |
| 7.8 | Distortion..... | 33 |
| 7.8.1 | Sending Distortion | 33 |
| 7.8.2 | Receiving | 34 |
| 7.9 | Ambient Noise Rejection | 34 |
| 8 | Wideband telephony transmission performance test methods | 35 |
| 8.1 | Applicability..... | 35 |
| 8.2 | Overall loss/loudness ratings..... | 35 |
| 8.2.1 | General..... | 35 |
| 8.2.2 | Connections with handset UE..... | 36 |
| 8.2.2.1 | Sending Loudness Rating (SLR)..... | 36 |
| 8.2.2.2 | Receiving Loudness Rating (RLR) | 36 |
| 8.2.3 | Connections with Vehicle Mounted & Desktop Mounted hands-free UE..... | 36 |
| 8.2.3.1 | Sending Loudness Rating (SLR)..... | 36 |
| 8.2.3.2 | Receiving Loudness Rating (RLR) | 37 |
| 8.2.4 | Connections with Handheld hands-free UE..... | 37 |
| 8.2.4.1 | Sending Loudness Rating (SLR)..... | 37 |
| 8.2.4.2 | Receiving Loudness Rating (RLR) | 38 |
| 8.2.5 | Connections with headset UE | 38 |
| 8.3 | Idle channel noise (handset and headset UE) | 38 |
| 8.3.1 | Sending | 38 |
| 8.3.2 | Receiving | 38 |
| 8.4 | Sensitivity/frequency characteristics | 39 |
| 8.4.1 | Handset and headset UE sending | 39 |
| 8.4.2 | Handset and headset UE receiving | 39 |
| 8.4.3 | Vehicle Mounted & Desktop hands-free UE sending..... | 39 |
| 8.4.4 | Vehicle Mounted & Desktop hands-free UE receiving | 40 |
| 8.4.5 | Hand-Held hands-free UE sending | 40 |
| 8.4.6 | Hand-Held hands-free UE receiving..... | 40 |
| 8.5 | Sidetone characteristics | 40 |
| 8.5.1 | Connections with Handset UE..... | 40 |
| 8.5.2 | Headset UE | 41 |
| 8.5.3 | Hands-free UE (all categories)..... | 41 |
| 8.5.4 | Sidetone delay for handset or headset..... | 41 |
| 8.6 | Stability loss | 42 |
| 8.7 | Acoustic echo control..... | 42 |
| 8.7.1 | General..... | 42 |
| 8.7.2 | Acoustic echo control in a hands-free UE | 42 |
| 8.7.3 | Acoustic echo control in a handset UE | 43 |
| 8.7.4 | Acoustic echo control in a headset UE | 44 |
| 8.8 | Distortion..... | 45 |

8.8.1 Sending Distortion45
8.8.2 Receiving45
8.9 Ambient Noise Rejection45
Annex A (informative): Change history48
History49

Foreword

This Technical Specification has been produced by the 3GPP.

The contents of the present document are subject to continuing work within the TSG and may change following formal TSG approval. Should the TSG modify the contents of this TS, it will be re-released by the TSG with an identifying change of release date and an increase in version number as follows:

Version x.y.z

where:

- x the first digit:
 - 1 presented to TSG for information;
 - 2 presented to TSG for approval;
 - 3 or greater indicates TSG approved document under change control.
- y the second digit is incremented for all changes of substance, i.e. technical enhancements, corrections, updates, etc.
- z the third digit is incremented when editorial only changes have been incorporated in the specification.

Introduction

The present document specifies test methods to allow the minimum performance requirements for the acoustic characteristics of GSM and 3G terminals when used to provide narrow-band or wideband telephony to be assessed.

The objective for narrow-band services is to reach a quality as close as possible to ITU-T standards for PSTN circuits. However, due to technical and economic factors, there cannot be full compliance with the general characteristics of international telephone connections and circuits recommended by the ITU-T.

The performance requirements are specified in TS 26.131; the test methods and considerations are specified in the main body of the text.

1 Scope

The present document is applicable to any terminal capable of supporting narrow-band or wideband telephony, either as a stand-alone service or as the telephony component of a multimedia service. The present document specifies test methods to allow the minimum performance requirements for the acoustic characteristics of GSM and 3G terminals when used to provide narrow-band or wideband telephony to be assessed.

2 References

The following documents contain provisions which, through reference in this text, constitute provisions of the present document.

- References are either specific (identified by date of publication, edition number, version number, etc.) or non-specific.
- For a specific reference, subsequent revisions do not apply.
- For a non-specific reference, the latest version applies. In the case of a reference to a 3GPP document (including a GSM document), a non-specific reference implicitly refers to the latest version of that document *in the same Release as the present document*.

- [1] 3GPP TS 26.131: "Terminal Acoustic Characteristics for Telephony; Requirements".
- [2] ITU-T Recommendation B.12 (1988): "Use of the decibel and the neper in telecommunications".
- [3] ITU-T Recommendation G.103 (1998): "Hypothetical reference connections".
- [4] ITU-T Recommendation G.111 (1993): "Loudness ratings (LRs) in an international connection".
- [5] ITU-T Recommendation G.121 (1993): "Loudness ratings (LRs) of national systems".
- [6] ITU-T Recommendation G.122 (1993): "Influence of national systems on stability, talker echo, and listener echo in international connections".
- [7] ITU-T Recommendation G.711 (1988): "Pulse code modulation (PCM) of voice frequencies".
- [8] ITU-T Recommendation P.11 (1993): "Effect of transmission impairments".
- [9] ITU-T Recommendation P.38 (1993): "Transmission characteristics of operator telephone systems (OTS)".
- [10] ITU-T Recommendation P.50 (1993): "Artificial voices".
- [11] 3GPP TS 03.58 (Release 1997): "Digital Cellular Telecommunications System (Phase 2+) Characterization test methods and quality assessment for hands-free mobiles".
- [12] IEC Publication 60651: 'Sound Level Meters'.
- [13] ITU-T Recommendation P.51 (1996): "Artificial mouth".
- [14] ITU-T Recommendation P.57 (2005): "Artificial ears".
- [15] ITU-T Recommendation P.58 (1996): "Head and torso simulator for telephonometry."
- [16] ITU-T Recommendation P.79 (2007) with Annex A: "Calculation of loudness ratings for telephone sets."
- [17] 3GPP TS 06.77 R99 Minimum Performance Requirements for Noise Suppressor Application to the AMR Speech Encoder.

- [18] ITU-T Recommendation P.64: "Determination of sensitivity/frequency characteristics of local telephone systems".
- [19] ITU-T Recommendation P.581: "Use of head and torso simulator (HATS) for hands-free terminal testing".
- [20] ITU-T Recommendation P.340: "Transmission characteristics of hands-free telephones".
- [21] ITU-T Recommendation G.712: "Transmission performance characteristics of pulse code modulation channels".
- [22] ITU-T Recommendation P.501: "Test signals for use in telephony".
- [23] ITU-T Recommendation O.41: "Psophometer for use on telephone-type circuits".
- [24] ITU-T Recommendation O.131: "Psophometer for use on telephone-type circuits".
- [25] ISO 9614: "Acoustics - Determination of sound power levels of noise sources using sound intensity".
- [26] ISO 3745: "Acoustics - Determination of sound power levels of noise sources - Precision methods for anechoic and semi-anechoic rooms".
- [27] ITU-T Recommendation O.132: "Quantizing distortion measuring equipment using a sinusoidal test signal".

3 Definitions, symbols and abbreviations

3.1 Definitions

For the purposes of the present document the term *narrow-band* refers to signals sampled at 8 kHz; *wideband* refers to signals sampled at 16 kHz.

For the purposes of the present document, the following terms: dB, dBr, dBm0, dBm0p and dBA, shall be interpreted as defined in ITU-T Recommendation B.12; the term dBPa shall be interpreted as the sound pressure level relative to 1 pascal expressed in dB (0 dBPa is equivalent to 94 dB SPL).

A 3GPP softphone is a telephony system running on a general purpose computer or PDA complying with the 3GPP terminal acoustic requirements (TS 26.131 and 26.132).

3.2 Abbreviations

For the purposes of the present document, the following abbreviations apply:

| | |
|------|--------------------------------------|
| ADC | Analogue to Digital Converter |
| DAC | Digital to Analogue Converter |
| DTX | Discontinuous Transmission |
| EEC | Electrical Echo Control |
| EL | Echo Loss |
| ERP | Ear Reference Point |
| HATS | Head and Torso Simulator |
| LSTR | Listener Sidetone Rating |
| LRGP | Loudness Rating Guardring Position |
| MRP | Mouth Reference Point |
| OLR | Overall Loudness Rating |
| PCM | Pulse Code Modulation |
| PDA | Personal Digital Assistant |
| POI | Point of Interconnection (with PSTN) |
| PSTN | Public Switched Telephone Network |
| RLR | Receive Loudness Rating |

| | |
|------|-------------------------|
| SLR | Send Loudness Rating |
| STMR | Sidetone Masking Rating |
| SS | System Simulator |
| TX | Transmission |
| UE | User Equipment |

4 Interfaces

Access to terminals for acoustic testing is always made via the acoustic or air interfaces. The Air Interface is specified by the GSM 05 or 45 and the 3G 25 series specifications and is required to achieve user equipment (UE) transportability. Measurements can be made at this point using a system simulator (SS) comprising the appropriate radio terminal equipment and speech transcoder. The losses and gains introduced by the test speech transcoder will need to be specified.

The POI with the public switched telephone network (PSTN) is considered to have a relative level of 0 dBr, where signals will be represented by 8-bit A-law, according to ITU-T Recommendation G.711. Measurements may be made at this point using a standard send and receive side, as defined in ITU-T Recommendations.

Five classes of acoustic interface are considered in this specification:

- Handset UE including softphone UE used as a handset;
- Headset UE including softphone UE used with headset;
- Vehicle Mounted Hands-free UE including softphone UE mounted in a vehicle;
- Desktop-mounted hands-free UE including softphone UE with external loudspeaker(s) used in handsfree mode;
- Handheld hands-free UE including softphone UE with internal loudspeaker(s) used in handsfree mode.

(See definition of softphone in Clause 3.1)

NOTE: The test setup for a softphone UE shall be derived according to the following rules:

- When using a softphone UE as a handset: the test setup shall correspond to handset mode.
- When using a softphone UE with headset: the test setup shall correspond to headset mode.
- When a softphone UE is mounted in a vehicle: the test setup shall correspond to Vehicle-mounted handsfree mode.
- When using a softphone UE in handsfree mode:
 - When using internal loudspeaker(s), the test setup shall correspond to handheld hands-free.
 - When using external loudspeaker(s), the test setup shall correspond to desktop-mounted hands-free.

5 Test configurations

This section describes the test setups for terminal acoustic testing.

NOTE: If the terminal has several mechanical configurations (e.g. sliding design open or closed), all manufacturer-defined configurations shall be tested.

5.1 Setup for terminals

The general access to terminals is described in Figure 1. The preferred acoustic access to GSM and 3G terminals is the most realistic simulation of the 'average' subscriber. This can be made by using HATS (head and torso simulator) or LRGP (Loudness Rating Guardring Position), with appropriate ear simulation and appropriate mountings for handset terminals in a realistic but reproducible, way to the HATS / LRGP. . Hands-free terminals shall use the HATS or free

field microphone techniques in a realistic but reproducible way. Headset measurement methods are for further study, awaiting input from ETSI TC-STQ.

HATS is described in ITU-T Recommendation P.58, appropriate ears are described in ITU-T Recommendation P.57 (type 3.3 and type 3.4 ear), a proper positioning of handsets in realistic conditions is found in ITU-T Recommendation P.64, the test setups for various types of hands-free terminals can be found in ITU-T Recommendation P.581.

LRGP is described in ITU-T Recommendation P.64, appropriate ears are described in ITU-T Recommendation P.57 (type 3.2).

The preferred way of testing is the connection of a terminal to the system simulator with exact defined settings and access points. The test sequences are fed in either, electrically using a reference codec or using the direct signal processing approach or acoustically using ITU-T specified devices.

5.1.1 Setup for handset terminals

HATS Method : When using a handset telephone the handset is placed in the HATS position as described in ITU-T Recommendation P.64. The artificial mouth shall conform with P.58 when HATS is used. The artificial ear shall conform with Rec. P.57, type 3.3 or type 3.4 ears shall be used.

LRGP Method : When using a handset telephone the handset is placed in the LRGP position as described in ITU-T Recommendation P.64. The artificial mouth shall conform with P.51 when LRGP is used. The artificial ear shall conform with Rec. P.57, type 3.2 ear shall be used. Either the high leak or low leak version may be used.

5.1.2 Setup for headset terminals

For further study.

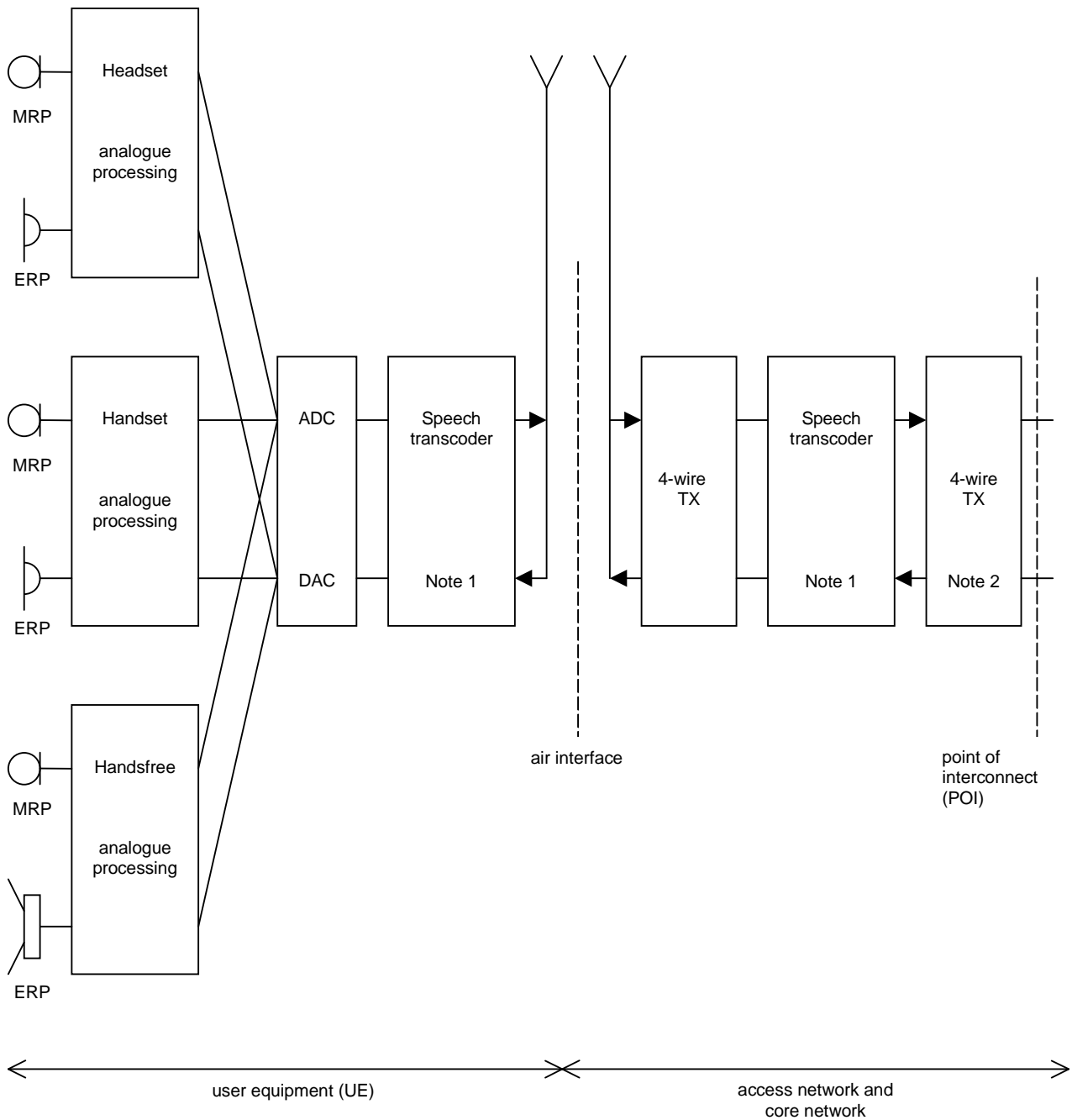

NOTE 1: Includes DTX functionality.

NOTE 2: Connection to PSTN should include electrical echo control (EEC).

Figure 1: GSM/3G Interfaces for specification and testing of terminal narrow-band acoustic characteristics

5.1.3 Setup for hands-free terminals

5.1.3.1 Vehicle mounted hands-free

Vehicle mounted hands-free may be measured either in a vehicle or in an anechoic room. For both of these two types of test environments, the setup will depend on whether HATS or a discrete artificial mouth and discrete microphone are used as the acoustic test equipment.

For in-vehicle measurements, if HATS test equipment is used, it should be positioned in the car as per ITU-T Recommendation P. 581. If in-vehicle measurements are made with a discrete microphone and discrete artificial mouth,

they should be positioned in the car as per Figure 2 and Figure 3, respectively. The artificial mouth should comply with ITU-T Recommendation P. 51. The microphone should be a pressure-field microphone complying with IEC 60651. The microphone should preferably be fitted with a random incidence corrector. A vehicle simulator may be used instead of an actual car. A standard vehicle simulator is described in ETSI 0358 601 (TR101110) Digital Cellular Telecommunications System (Phase 2+) Characterisation test methods and quality assessment for hands-free mobiles. The hands-free equipment is mounted in the car as specified by the manufacturer.

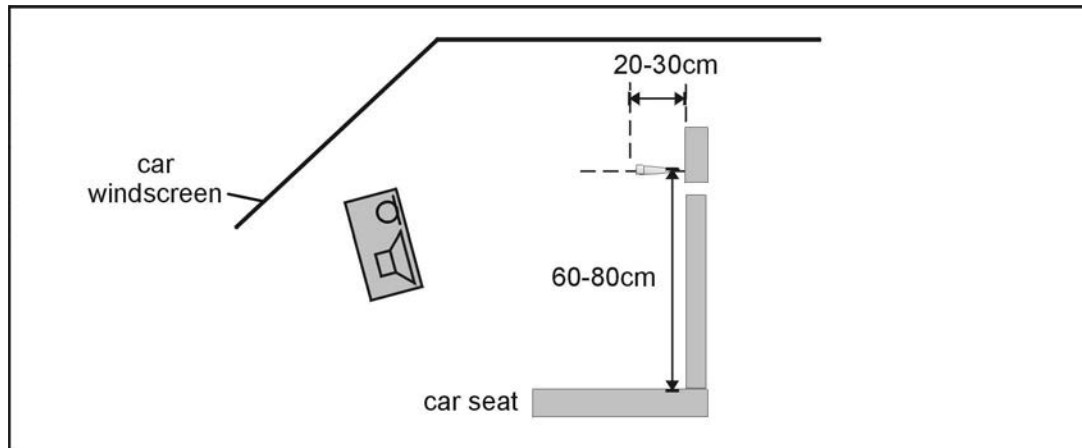

Figure 2: Test Configuration for Vehicle mounted hands-free, receiving characteristics, with discrete measurement microphone

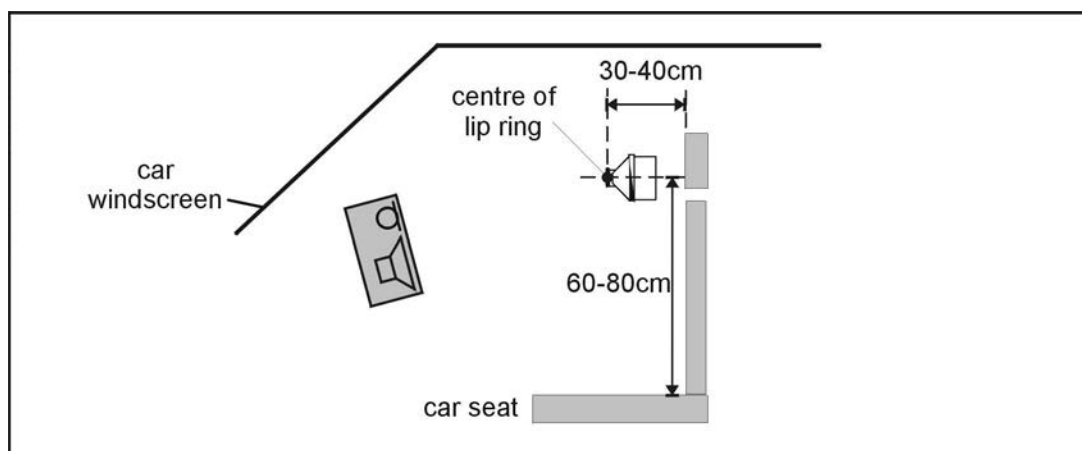

Figure 3: Test Configuration for Vehicle mounted hands-free, sending characteristics, with discrete P. 51 artificial mouth

Specification testing of vehicle-mounted hands-free equipment in an anechoic room is for further study.

5.1.3.2 Desktop mounted hands-free

For HATS test equipment, definition of hands-free terminals and setup for desktop hands-free terminals can be found in ITU-T Recommendation P.581. Measurement setup using a free field microphone and a discrete P.51 artificial mouth for desktop hands-free terminals can be found in ITU-T Recommendation P.340.

5.1.3.3 Handheld hands-free

Either HATS or a free-field microphone with a discrete P. 51 artificial mouth may be used to measure Hand-Held Hands-free type UE.

If HATS measurement equipment is used, it should be configured to the Hand-Held Hands-free UE according to Figure 4. The HATS should be positioned so that the HATS Reference Point is at a distance d_{HF} from the centre point of the visual display of the Mobile Station. The distance d_{HF} is specified by the manufacturer. A vertical angle θ_{HF} may be specified by the manufacturer. In case it is not specified the distance d_{HF} shall be 42 cm and θ_{HF} shall be 0.

NOTE: The nominal distance of 42 cm corresponds to lip plane-HATS reference point distance (12 cm) with an additional 30 cm giving a realistic figure as a reference usage of handheld terminals.

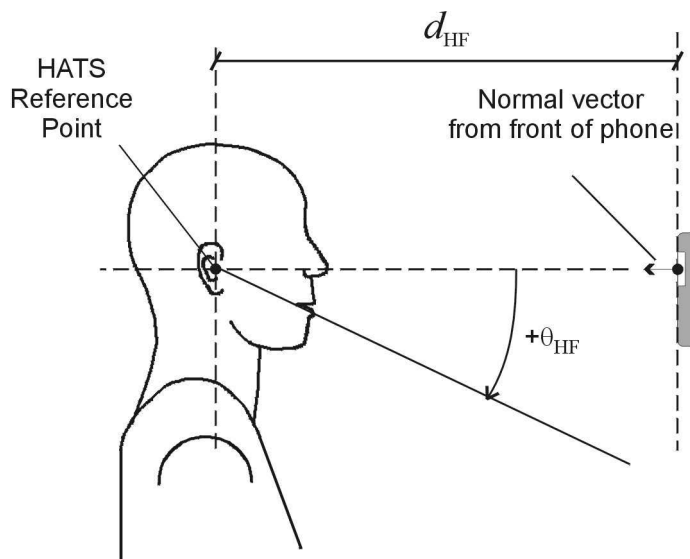

Figure 4: Configuration of Hand-Held Hands-free UE relative to the HATS

If a free-field microphone with a discrete P. 51 mouth are used, they should be configured to the Hand-Held Hands-free UE as per Figure 5 for receiving measurements and Figure 6 for sending measurements. The measurement instrument should be located at a distance d_{HF} from the centre of the visual display of the Mobile Station. The distance d_{HF} is specified by the manufacturer.

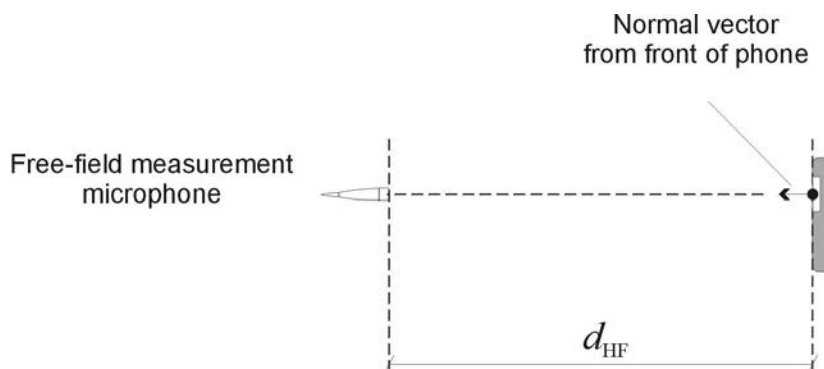

Figure 5: Configuration of Hand-Held Hands-free UE, free-field microphone for receiving measurements

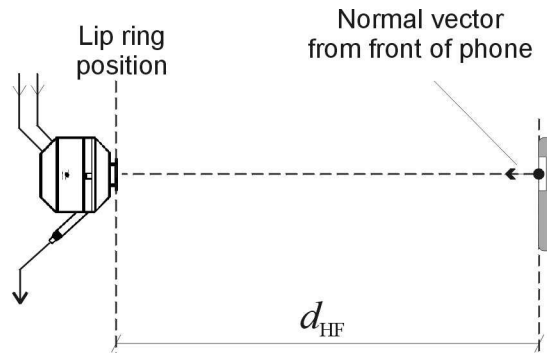

Figure 6: Configuration of Hand-Held Hands-free UE, discrete P. 51 artificial mouth for sending measurements

5.1.4 Position and calibration of HATS

The horizontal positioning of the HATS reference plane shall be guaranteed within $\pm 2^\circ$ for testing hands-free equipment.

The HATS shall be equipped with either Type 3.3 or 3.4 Artificial Ear. For hands-free measurements the HATS shall always be equipped with two artificial ears. The pinnas are specified in Recommendation P.57 for Types 3.3 and 3.4 artificial ears. The pinna shall be positioned on HATS according to ITU-T Recommendation P.58 .

The exact calibration and equalization procedures as well as the combination of the two ear signals for the purpose of measurements can be found in ITU-T Recommendation P.581. For Handheld hands-free UE, the set-up corresponding to 'portable hands-free' in P. 581 should be used.

5.2 Setup of the electrical interfaces

5.2.1 Codec approach and specification

Codec approach: In this approach, a codec is used to convert the companded digital input/output bit-stream of the system simulator to the equivalent analogue values. With this approach a system simulator, simulating the radio link to the terminal under controlled and error free conditions is required. The system simulator has to be equipped with a high-quality codec whose characteristics are as close as possible to ideal.

Definition of 0 dB_r point:

D/A converter - a Digital Test Sequence (DTS) representing the codec equivalent of an analogue sinusoidal signal whose rms value is 3,14 dB below the maximum full-load capacity of the codec shall generate 0 dBm across a 600 ohm load;

A/D converter - a 0 dBm signal generated from a 600 ohm source shall give the digital test sequence (DTS) representing the codec equivalent of an analogue sinusoidal signal whose RMS value is 3,14 dB below the maximum full-load capacity of the codec.

Narrow band telephony testing

For testing a GSM or 3G terminal supporting narrow-band telephony, the system simulator shall use the AMR speech codec as defined in 3GPP TS 26 series specifications, at the source coding bit rate of 12,2kbit/s. The transcoding from the output of the AMR speech coding in the system simulator to analogue signals shall be carried out using an ITU-T G.711 codec performing to ITU-T G.712 (4-wire analogue).

Wide band telephony testing

For testing a GSM or 3G terminal supporting wide-band telephony, the system simulator shall use the AMR-WB speech codec as defined in 3GPP TS26 series specifications, at the source coding bit rate of 12.65 kbit/s. The transcoding from the output of the AMR-WB speech coding in the system simulator to analogue signals shall be carried out using an ITU-T G.711 codec performing to ITU-T G.712 (4-wire analogue).

5.2.2 Direct digital processing approach

In this approach, the companded digital input/output bit-stream of the terminal connected through the radio link to the system simulator is operated upon directly. For the purposes of GSM/3G acoustic testing, the direct digital processing shall use the default speech codec, the AMR speech codec as defined in 3GTS26 series specifications, at it's highest source coding bit rate of 12,2kbit/s.

Narrow band telephony testing

For testing a GSM or 3G terminal supporting narrow-band telephony, the system simulator shall use the AMR speech codec as defined in 3GPP TS 26 series specifications, at the source coding bit rate of 12,2kbit/s.

Wide band telephony testing

For testing a GSM or 3G terminal supporting wide-band telephony, the system simulator shall use the AMR-WB speech codec as defined in 3GPP TS26 series specifications, at the source coding bit rate of 12.65 kbit/s.

5.3 Accuracy of test equipment

Unless specified otherwise, the accuracy of measurements made by test equipment shall be better than:

| Item | Accuracy |
|-------------------------|--|
| Electrical Signal Power | $\pm 0,2$ dB for levels ≥ -50 dBm |
| Electrical Signal Power | $\pm 0,4$ dB for levels < -50 dBm |
| Sound pressure | $\pm 0,7$ dB |
| Time | ± 5 % |
| Frequency | $\pm 0,2$ % |

Unless specified otherwise, the accuracy of the signals generated by the test equipment shall be better than:

| Quantity | Accuracy |
|---|--|
| Sound pressure level at MRP | ±1 dB for 200 Hz to 4 kHz ±3 dB for 100 Hz to 200 Hz and 4 kHz to 8 kHz |
| Electrical excitation levels | ±0,4 dB (see note 1) |
| Frequency generation | ±2 % (see note 2) |
| NOTE 1: Across the whole frequency range. NOTE 2: When measuring sampled systems, it is advisable to avoid measuring at sub-multiples of the sampling frequency. There is a tolerance of ±2 % on the generated frequencies, which may be used to avoid this problem, except for 4 kHz where only the -2 % tolerance may be used. | |

The measurements results shall be corrected for the measured deviations from the nominal level.
The sound level measurement equipment shall conform to IEC 651 Type 1.

5.4 Test signals

Due to the coding of the speech signals, standard sinusoidal test signals are not applicable for GSM/3G acoustic tests, appropriate test signals (general description) are defined in ITU-T Recommendation P.50 and P.501. Normative requirements for the use of test signals from P.501 are for further study. For the time being, if test signals from P.501 are used, a multisine signal is recommended. More information can be found in the test procedures described below.

NOTE: As stated in section 5.2 for narrow-band telephony the AMR speech codec shall be used at the highest source coding bit rate of 12.2kbit/s for all measurements. Tests at lower bit rates are not covered by 3GPP TS 26.132. If measurements of loudness ratings are still performed at lower bit rates the use of multisine signal is not recommended, because the results depend on the selected bit rate.

For testing the narrow-band telephony service provided by a terminal the test signal used shall be band limited between 100 Hz and 4 kHz with a bandpass filter providing a minimum of 24 dB/Oct. filter roll off, when feeding into the receiving direction.

For testing the wide-band telephony service provided by a terminal the test signal used shall be band limited between 100 Hz and 8 kHz with a bandpass filter providing a minimum of 24 dB/Oct. filter roll off, when feeding into the receiving direction.

The test signal levels are referred to the average level of the (band limited in receiving direction) test signal, averaged over the complete test sequence . unless specified otherwise.

5.5 Additional setup for wideband testing

5.5.1 Setup for handsets and headsets

When using a handset telephone the handset is placed on HATS as described in ITU-T Recommendation P.64 [18] The artificial mouth shall conform with ITU-T Recommendation P.58 [15]. The artificial ear shall be conform with ITU-T Recommendation P.57 [14], type 3.3 or type 3.4 ears shall be used.

Recommendations for positioning headsets are given in ITU-T Recommendation P.380 [28]. If not stated otherwise headsets shall be placed in their recommended wearing position. Further information about setup and the use of HATS can be found in ITU-T Recommendation P.380 [28].

Unless stated otherwise if a volume control is provided the setting is chosen such that the nominal RLR is met as close as possible.

Position and calibration of HATS

All the sending and receiving characteristics shall be tested with the HATS, it shall be indicated what type of ear was used at what application force. For handsets, if not stated otherwise in TS 26.131, 8 +/- 2 N application force shall be used.

The horizontal positioning of the HATS reference plane shall be guaranteed within $\pm 2^\circ$.

The HATS shall be equipped with two type 3.3 or type 3.4 artificial ears. For binaural headsets two artificial ears are required. The type 3.3 or type 3.4 artificial ears as specified in ITU-T Recommendation P.57 [14] shall be used. The artificial ear shall be positioned on HATS according to ITU-T Recommendation P.58 [15].

5.5.2 Additional test setup for handsfree function with softphone UE

This test setup is applicable to laptop computers or similar devices as seen in Figures 7 to 15.

When manufacturer gives conditions of use, they will apply for test. If no other requirement is given by manufacturer softphone will be positioned according the following conditions:

5.5.2.1 Softphone including speakers and microphone

Measurement with artificial ear and microphone:

Artificial mouth (for sending tests)

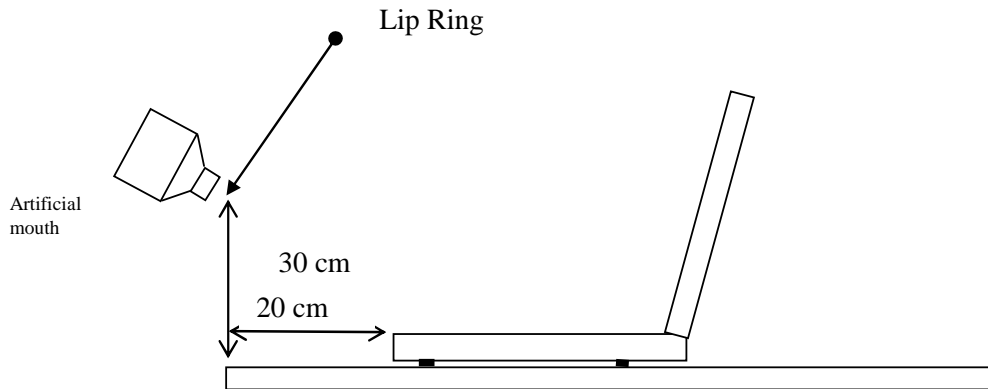

Figure 7: Configuration of softphone relative to the artificial mouth side view

Free field microphone (for receiving):

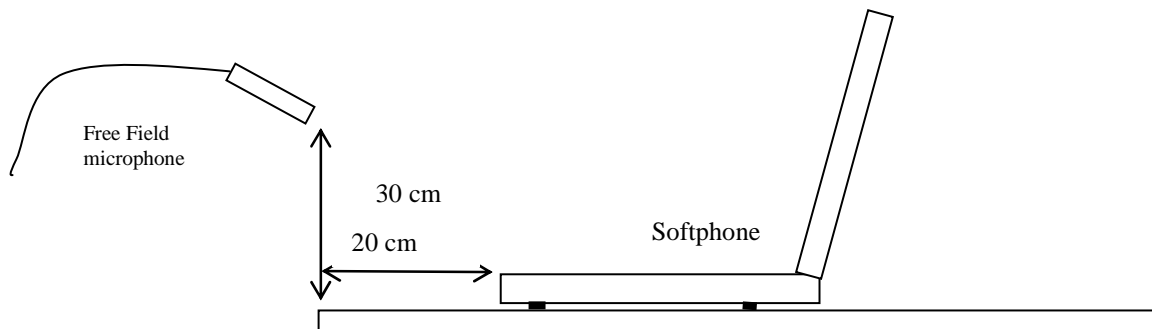

Figure 8: Configuration of softphone relative to the free field microphone side view

Position of softphone on the table:

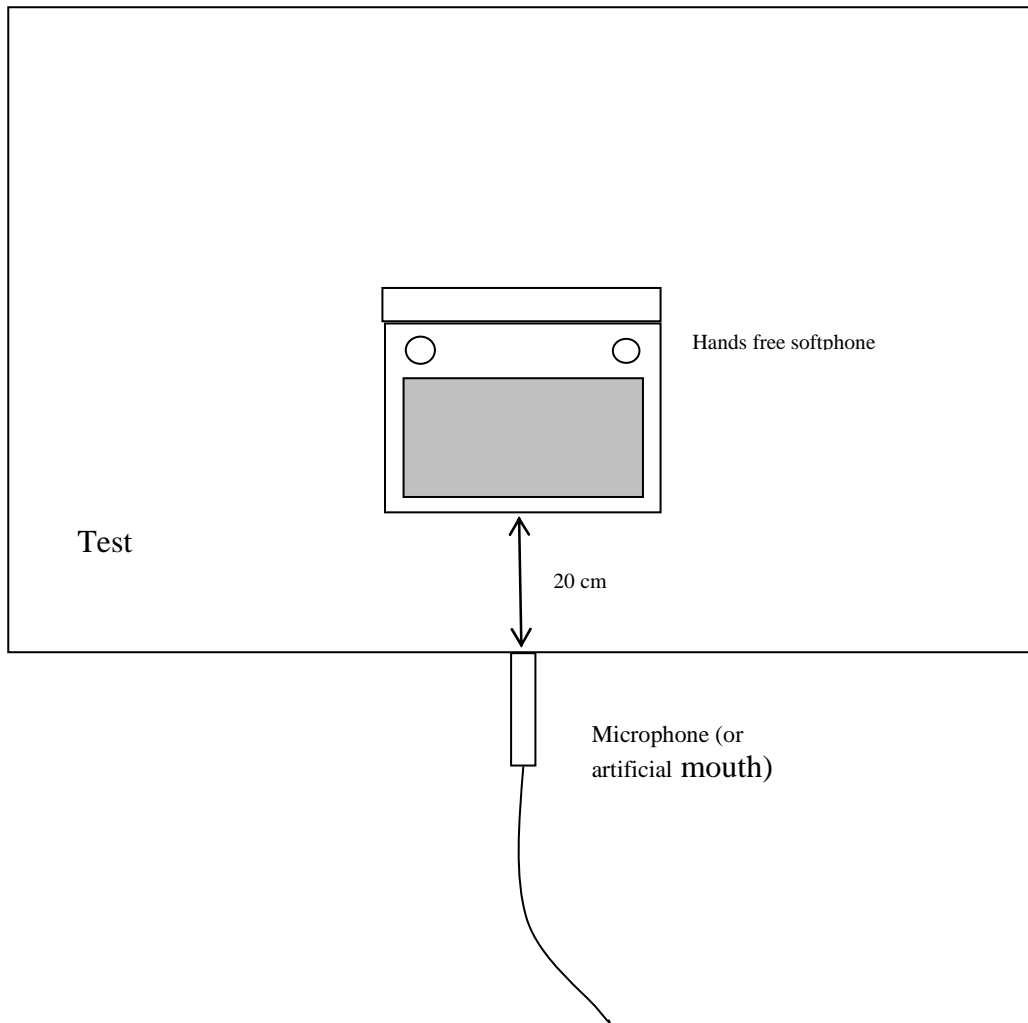

Figure 9: Configuration of softphone relative to the free field microphone or artificial mouth top sight

Measurement with HATS:

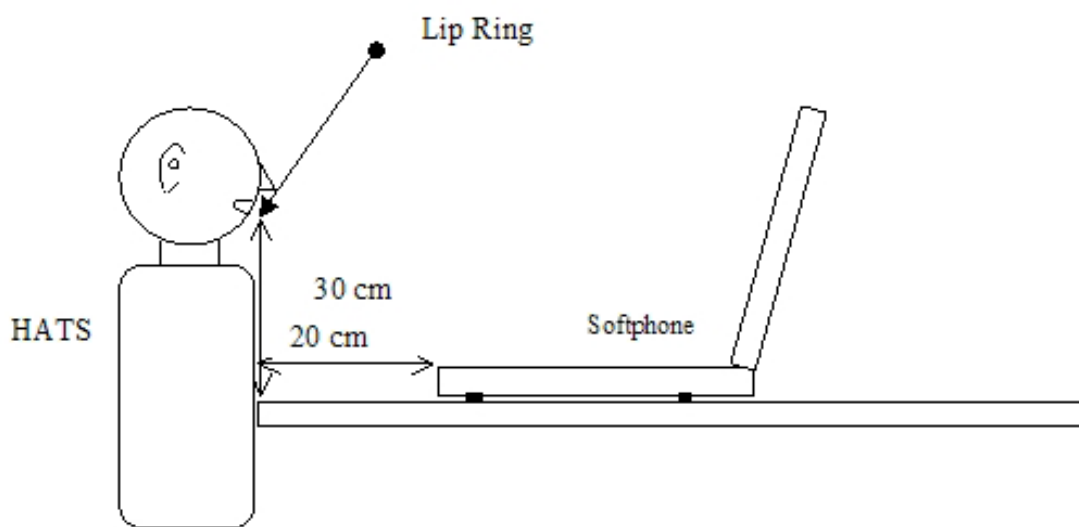

Figure 10: Configuration of softphone relative to the HATS side view

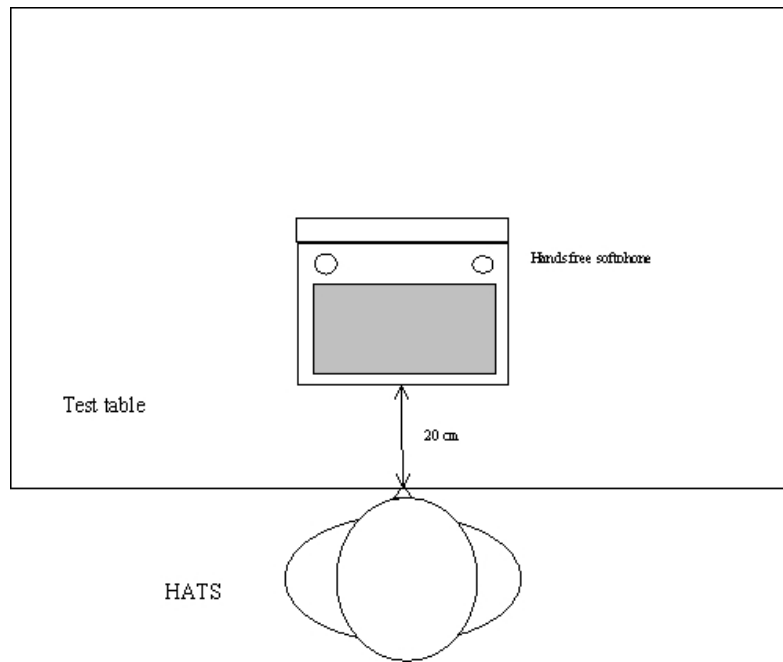

Figure 11: Configuration of softphone relative to the HATS top sight

5.5.2.2 Softphone with separate speakers

When separate loudspeakers are used, system will be positioned as in Figure 12 or 13.

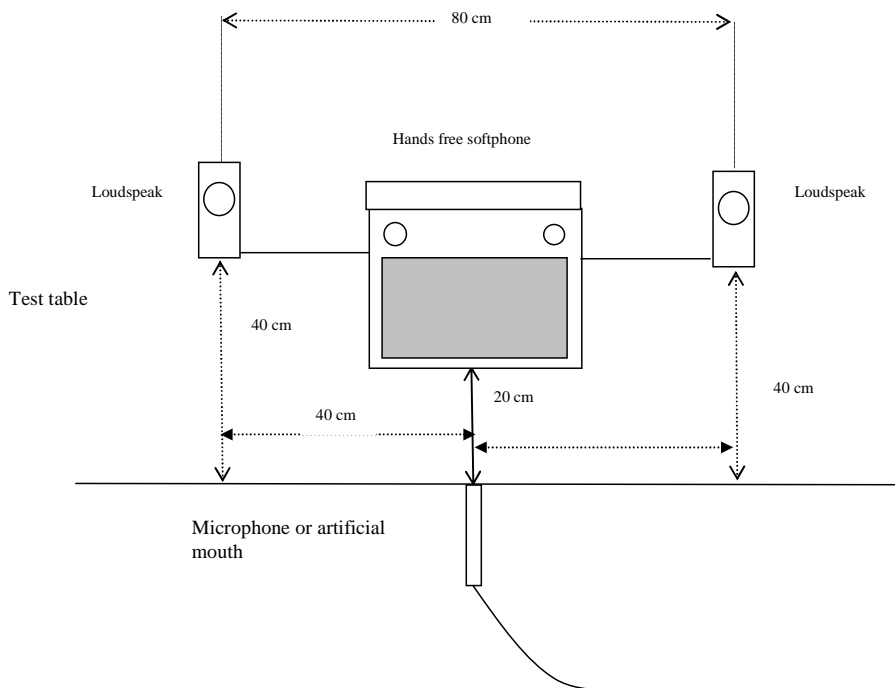

Figure 12: Configuration of softphone using external speakers relative to microphone or artificial mouth top sight

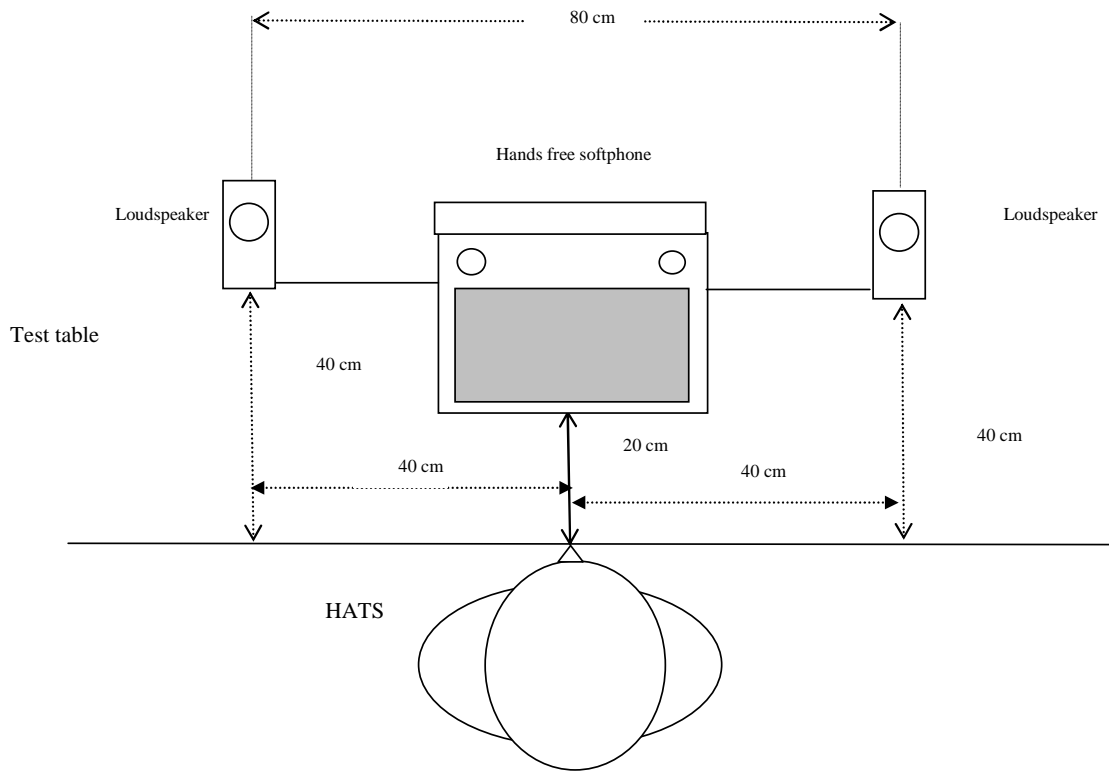

Figure 13: Configuration of softphone using external speakers relative to the HATS top sight

When external microphone and speakers are used, system will be positioned as in Figure 14 or 15.

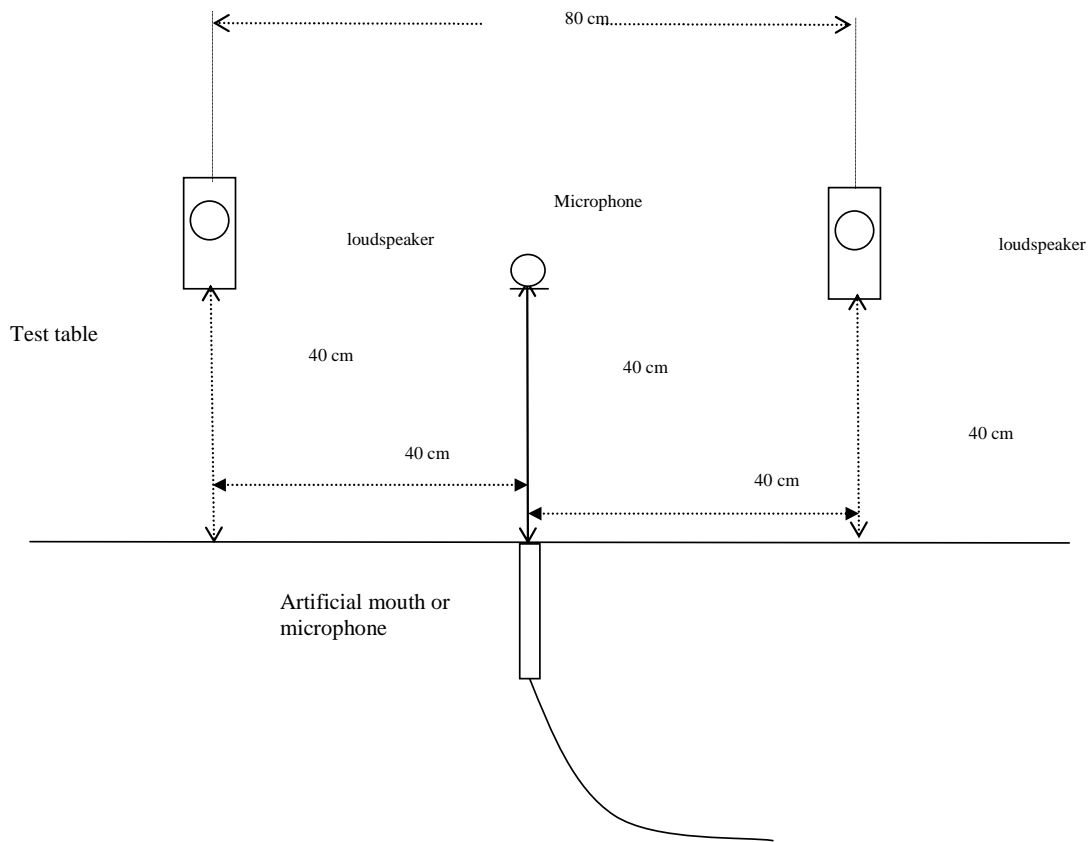

Figure 14: Configuration of softphone using external speakers and microphone relative to microphone or artificial mouth top sight

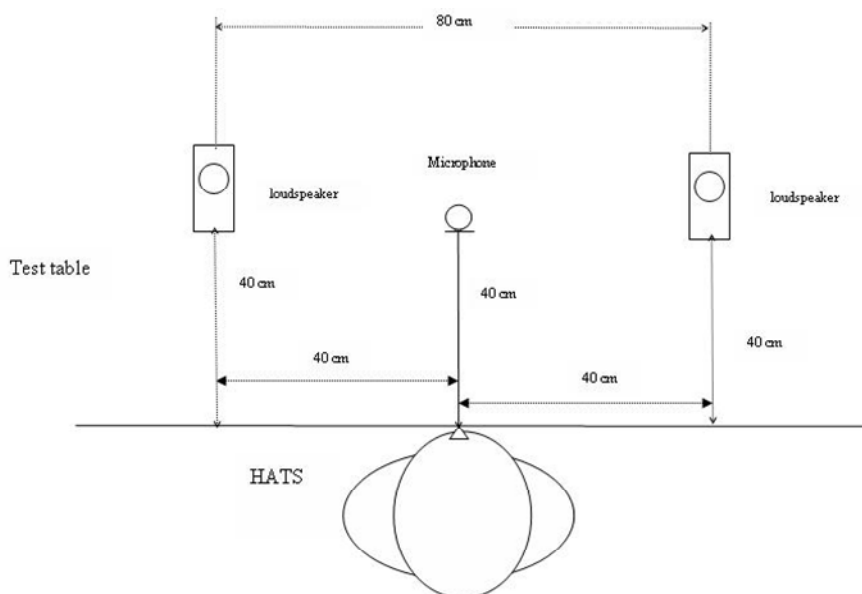

Figure 15: Configuration of softphone using external speakers and microphone relative to the HATS top sight

6 Test conditions

6.1 Environmental conditions

6.1.1 Handset and headset terminals

The environmental conditions for testing handset and headset UE is specified in §6.1.1 TS 26.132, as follows:

For handset and headset measurements the test room shall be practically free-field down to a lowest frequency of 275 Hz, the handset or the headset including the HATS / LRGP shall lie totally within this free-field volume. This shall be met if deviations of the ideal free-field conditions are less than ± 1 dB. Qualification of the test room may be performed using the method described in either ISO 3745 Annex A, or ITU-T P. 340 §5.4.

Alternatively, a test room may be used which meets the following two criteria:

1. The relationship between the pressure at the mouth opening and that at 5,0, 7,5 and 10 cm in front of the centre of the lip ring is within ± 0.5 dB of that which exists in a known acoustic free-field.
2. The relationship between the pressure at the mouth opening and at the Ear canal Entrance Point (EEP) at both the left and right ears of the HATS does not differ by more than ± 1 dB from that which exists in a known free-field.

The ambient noise level shall be less than -30 dBPa(A), for idle channel noise measurements the ambient noise level shall be less than -64 dBPa(A).

Echo measurements shall be conducted in realistic rooms with an ambient noise level less than -64 dBPa(A).

6.1.2 Hands-free terminals

Hands-free terminals generally should be tested in their typical environment of application. Care must be taken, that e.g. noise levels are sufficiently low in order not to interfere with the measurements.

For Desk-Top hands-free terminals the appropriate requirements shall be taken from ITU-Recommendation P.340.

The broadband noise level shall not exceed -70 dBPa(A). The octave band noise level shall not exceed the values specified in Table 2.

TABLE 2: P.340 Noise level

| Center frequency (Hz) | Octave band pressure level (dBPa) |
|-----------------------|-----------------------------------|
| 63 | -45 |
| 125 | -60 |
| 250 | -65 |
| 500 | -65 |
| 1 k | -65 |
| 2 k | -65 |
| 4 k | -65 |
| 8 k | -65 |

Echo measurements shall be conducted in realistic rooms with an ambient noise level less than -70 dBPa(A).

6.2 System Simulator conditions

The system simulator should provide an error free radio connection to the UE under test. The default speech codec in narrowband, the AMR speech codec, shall be used at its highest bit rate of 12,2 kbit/s. The default speech codec, in wideband, AMR-WB, shall be used at 12,65 kbit/s. Discontinuous Transmission, DTX, (silence suppression) shall be disabled for the purposes of GSM/3G acoustic testing.

7 Narrow-band telephony transmission performance test methods

7.1 Applicability

The test methods in this sub-clause shall apply when testing a UE which is used to provide narrow-band or wideband telephony, either as a stand-alone service, or as part of a multimedia service.

7.2 Overall loss/loudness ratings

7.2.1 General

The SLR and RLR values for the GSM or 3G network apply up to the POI. However, the main determining factors are the characteristics of the UE, including the analogue to digital conversion (ADC) and digital to analogue conversion (DAC). In practice, it is convenient to specify loudness ratings to the Air Interface. For the normal case, where the GSM or 3G network introduces no additional loss between the Air Interface and the POI, the loudness ratings to the PSTN boundary (POI) will be the same as the loudness ratings measured at the Air Interface.

7.2.2 Connections with handset UE

7.2.2.1 Sending Loudness Rating (SLR)

- a) The test signal to be used for the measurements shall be the artificial voice according to ITU-Recommendation P. 50 or a speech like test signal as described in ITU-T Recommendation P.501. The type of test signal used shall be stated in the test report. The spectrum of acoustic signal produced by the artificial mouth is calibrated under free field conditions at the MRP. The test signal level shall be $-4,7$ dBPa, measured at the MRP. The test signal level is averaged over the complete test signal sequence.
- b) The handset terminal is setup as described in subclause 5. The handset is mounted at the HATS or LRGP position (see ITU-T Recommendation P.64). The application force used to apply the handset against the artificial ear shall be within the range specified in ITU-T Recommendation P.64.

The sending sensitivity shall be calculated from each band of the 14 frequencies given in table 1 of ITU-T Recommendation P.79, bands 4 to 17. For the calculation the averaged measured level at the electrical reference point for each frequency band is referred to the averaged test signal level measured in each frequency band at the MRP.

- c) The sensitivity is expressed in terms of dBV/Pa and the SLR shall be calculated according to ITU-T Recommendation P.79, formula (A-23b), over bands 4 to 17, using $m = 0,175$ and the sending weighting factors from ITU-T Recommendation P.79, table 1.

7.2.2.2 Receiving Loudness Rating (RLR)

- a) The test signal to be used for the measurements shall be the artificial voice according to ITU-Recommendation P. 50 or a speech like test signal as described in ITU-T Recommendation P.501. The type of test signal used shall be stated in the test report. The test signal level shall be -16 dBm0, measured at the digital reference point or the equivalent analogue point. The test signal level is averaged over the complete test signal sequence.
- b) The handset terminal is setup as described in subclause 5. The handset is mounted at the HATS or LRGP position (see ITU-T Recommendation P.64). The application force used to apply the handset against the artificial ear shall be within the range specified in ITU-T Recommendation P.64. The receiving sensitivity shall be calculated from each band of the 14 frequencies given in table 1 of ITU-T Recommendation P.79, bands 4 to 17. For the calculation, the averaged measured level at each frequency band is referred to the averaged test signal level measured in each frequency band.
- c) The sensitivity is expressed in terms of dBPa/V and the RLR shall be calculated according to ITU-T Recommendation P.79 [16], formula (A-23c), over bands 4 to 17, using $m = 0,175$ and the receiving weighting factors from table 1 of ITU-T Recommendation P.79 [16].
- d) No leakage correction shall be applied.

7.2.3 Connections with Vehicle Mounted & Desk-Top hands-free UE

Vehicle mounted hands-free should be tested in the vehicle (for the totally integrated vehicle hands-free systems) or in a vehicle simulator, ref ETSI 0358 601 (TR101110) Digital Cellular Telecommunications System (Phase 2+) Characterization test methods and quality assessment for hands-free mobiles.

Free Field measurements for vehicle mounted hands-free are for further study.

7.2.3.1 Sending Loudness Rating (SLR)

- a) The test signal to be used for the measurements shall be the artificial voice according to ITU-Recommendation P. 50 or a speech like test signal as described in ITU-T Recommendation P.501. The type of test signal used shall be stated in the test report. The spectrum of acoustic signal produced by the artificial mouth is calibrated under free field conditions at the MRP. The test signal level shall be $-4,7$ dBPa, measured at the MRP. The test signal level is averaged over the complete test signal sequence. The broadband signal level then is adjusted to $-28,7$ dBPa at the HFRP or the HATSHFRP (as defined in P.581) and the spectrum is not altered.

The spectrum at the MRP and the actual level at the MRP (measured in third octaves) is used as reference to determine the sending sensitivity S_{mJ} .

- b) The hands-free terminal is setup as described in subclause 5. The sending sensitivity shall be calculated from each band of the 14 frequencies given in table 1 of ITU-T Recommendation P.79 , bands 4 to 17. For the calculation the averaged measured level at the electrical reference point for each frequency band is referred to the averaged test signal level measured in each frequency band at the MRP.
- c) The sensitivity is expressed in terms of dBV/Pa and the SLR shall be calculated according to ITU-T Recommendation P.79, formula (A-23b), over bands 4 to 17, using $m = 0,175$ and the sending weighting factors from ITU-T Recommendation P.79, table 1.

7.2.3.2 Receiving Loudness Rating (RLR)

- a) The test signal to be used for the measurements shall be the artificial voice according to ITU-Recommendation P. 50 or a speech like test signal as described in ITU-T Recommendation P.501. The type of test signal used shall be stated in the test report. The test signal level shall be -16 dBm0, measured at the digital reference point or the equivalent analogue point. The test signal level is averaged over the complete test signal sequence.
- b) The hands-free terminal is setup as described in subclause 5. If HATS is used then it is freefield equalized as described in ITU-T Recommendation P.581. The equalized output signal of each artificial ear is power-averaged on the total time of analysis; the 'right' and 'left' signals are voltage-summed for each 1/3 octave band frequency band; these 1/3 octave band data are considered as the input signal to be used for calculations or measurements. The receiving sensitivity shall be calculated from each band of the 14 frequencies given in table 1 of ITU-T Recommendation P.79 , bands 4 to 17.

For the calculation the averaged measured level at each frequency band is referred to the averaged test signal level measured in each frequency band.

- c) The sensitivity is expressed in terms of dBPa/V and the RLR shall be calculated according to ITU-T Recommendation P.79 [16], formula (A-23c), over bands 4 to 17, using $m = 0,175$ and the receiving weighting factors from table 1 of ITU-T Recommendation P.79.
- d) No leakage correction shall be applied. The hands-free correction as described in P.340 shall be applied. To compute Receiving loudness rating (RLR) for hands-free terminal (see also ITU-T Recommendation P.340), when using the combination of left and right ear signals from HATS the HFL_E has to be 8 dB, instead of 14 dB. For further information see ITU-T Recommendation P.581.

7.2.4 Connections with Handheld hands-free UE

7.2.4.1 Sending Loudness Rating (SLR)

- a) The test signal to be used for the measurements shall be the artificial voice according to ITU-Recommendation P. 50 or a speech like test signal as described in ITU-T Recommendation P.501. The type of test signal used shall be stated in the test report. The spectrum of acoustic signal produced by the artificial mouth is calibrated under free field conditions at the MRP. The test signal level shall be $-4,7$ dBPa, measured at the MRP. The test signal level is averaged over the complete test signal sequence. The broadband signal level then is adjusted to $-28,7$ dBPa at the HFRP or the HATSHFRP (as defined in P. 581) and the spectrum is not altered.

The spectrum at the MRP and the actual level at the MRP (measured in third octaves) is used as reference to determine the sending sensitivity S_{mJ} .

- b) The hands-free terminal is setup as described in subclause 5.1.3.3. The sending sensitivity shall be calculated from each band of the 14 frequencies given in table 1 of ITU-T Recommendation P.79, bands 4 to 17. For the calculation the averaged measured level at the electrical reference point for each frequency band is referred to the averaged test signal level measured in each frequency band at the MRP.
- c) The sensitivity is expressed in terms of dBV/Pa and the SLR shall be calculated according to ITU-T Recommendation P.79, formula (A-23b), over bands 4 to 17, using $m = 0,175$ and the sending weighting factors from ITU-T Recommendation P.79, table 1.

7.2.4.2 Receiving Loudness Rating (RLR)

- a) The test signal to be used for the measurements shall be the artificial voice according to ITU-Recommendation P. 50 or a speech like test signal as described in ITU-T Recommendation P.501. The type of test signal used shall be stated in the test report. The test signal level shall be -16 dBm₀, measured at the digital reference point or the equivalent analogue point. The test signal level is averaged over the complete test signal sequence.
- b) The hands-free terminal is setup as described in subclause 5.1.3.3. If HATS is used then it is freefield equalized as described in ITU-T Recommendation P.581. The equalized output signal of each artificial ear is power-averaged on the total time of analysis; the 'right' and 'left' signals are voltage-summed for each 1/3 octave band frequency band; these 1/3 octave band data are considered as the input signal to be used for calculations or measurements. The receiving sensitivity shall be calculated from each band of the 14 frequencies given in table 1 of ITU-T Recommendation P.79, bands 4 to 17.

For the calculation the averaged measured level at each frequency band is referred to the averaged test signal level measured in each frequency band.

- c) The sensitivity is expressed in terms of dBPa/V and the RLR shall be calculated according to ITU-T Recommendation P.79 [16], formula (A-23c), over bands 4 to 17, using $m = 0,175$ and the receiving weighting factors from table 1 of ITU-T Recommendation P.79.
- d) No leakage correction shall be applied. The hands-free correction as described in P.340 shall be applied. To compute the Receiving loudness rating (RLR) for hands-free terminals (see also ITU-T Recommendation P.340) when using the combination of left and right ear signals from HATS the HFL_E has to be 8 dB, instead of 14 dB. For further information see ITU-T Recommendation P.581.

7.2.5 Connections with headset UE

For Further study

7.3 Idle channel noise (handset and headset UE)

7.3.1 Sending

The terminal should be configured to the test equipment as described in subclause 5.1.

The environment shall comply with the conditions described in subclause 6.1 for idle channel noise measurement.

For testing narrow-band functionality, the Psophometric noise level at the output of the SS is measured. The psophometric filter is described in ITU-T Recommendation O.41.

For testing wideband functionality, the A-weighted noise level at the output of the SS is measured. The A-weighting filter is described in IEC 60651.

A test signal may have to be intermittently applied to prevent "silent mode" operation of the MS. This is for further study.

7.3.2 Receiving

The terminal should be configured to the test equipment as described in subclause 5.1.

The environment shall comply with the conditions described in subclause 6.1.

A test signal may have to be intermittently applied to prevent "silent mode" operation of the MS. This is for further study.

For testing narrow-band or wideband functionality, the A-weighted level of the noise shall be measured at the ERP. The A-weighting filter is described IEC 60651 [12].

7.4 Sensitivity/frequency characteristics

7.4.1 Handset UE sending

- a) The test signal to be used for the measurements shall be the artificial voice according to ITU-Recommendation P. 50 or a speech like test signal as described in ITU-T Recommendation P.501. The type of test signal used shall be stated in the test report. The spectrum of acoustic signal produced by the artificial mouth is calibrated under free field conditions at the MRP. The test signal level shall be $-4,7$ dBPa, measured at the MRP. The test signal level is averaged over the complete test signal sequence.
- b) The handset terminal is setup as described in subclause 5. The handset is mounted at the HATS / LRGP position (see ITU-T Recommendation P.64). The application force used to apply the handset against the artificial ear shall be within the range specified in ITU-T Recommendation P.64.

Measurements shall be made at one twelfth-octave intervals as given by the R.40 series of preferred numbers in ISO 3 [17] for frequencies from 100 Hz to 4 kHz inclusive. For the calculation the averaged measured level at the electrical reference point for each frequency band is referred to the averaged test signal level measured in each frequency band at the MRP.

- c) The sensitivity is expressed in terms of dBV/Pa.

7.4.2 Handset UE receiving

- a) The test signal to be used for the measurements shall be the artificial voice according to ITU-Recommendation P. 50 or a speech like test signal as described in ITU-T Recommendation P.501. The type of test signal used shall be stated in the test report. The test signal level shall be -16 dBm₀, measured at the digital reference point or the equivalent analogue point. The test signal level is averaged over the complete test signal sequence.
- b) The handset terminal is setup as described in subclause 5. The handset is mounted at the HATS / LRGP position (see ITU-T Recommendation P.64). The application force used to apply the handset against the artificial ear shall be within the range specified in ITU-T Recommendation P.64.

Measurements shall be made at one twelfth-octave intervals as given by the R.40 series of preferred numbers in ISO 3 [17] for frequencies from 100 Hz to 4 kHz inclusive. For the calculation the averaged measured level at each frequency band is referred to the averaged test signal level measured in each frequency band.

- c) The sensitivity is expressed in terms of dBPa/V, referred to the ERP. Information about correction factors are available in ITU-T Recommendation P.57.

7.4.3 Vehicle Mounted & Desk-Top hands-free UE sending

- a) The test signal to be used for the measurements shall be the artificial voice according to ITU-Recommendation P. 50 or a speech like test signal as described in ITU-T Recommendation P.501. The type of test signal used shall be stated in the test report. The spectrum of acoustic signal produced by the artificial mouth is calibrated under free field conditions at the MRP. The test signal level shall be $-4,7$ dBPa, measured at the MRP. The test signal level is averaged over the complete test signal sequence. The broadband signal level then is adjusted to $-28,7$ dBPa at the HFRP or the HATSHFRP (as defined in P. 581) and the spectrum is not altered.

The spectrum at the MRP and the actual level at the MRP (measured in third octaves) is used as reference to determine the sending sensitivity S_{mJ} .

- b) The hands-free terminal is setup as described in subclause 5. Measurements shall be made at one third-octave intervals as given by the R.40 series of preferred numbers in ISO 3 [17] for frequencies from 100 Hz to 4 kHz inclusive. For the calculation the averaged measured level at each frequency band is referred to the averaged test signal level measured in each frequency band.
- c) The sensitivity is expressed in terms of dBV/Pa.

7.4.4 Vehicle Mounted & Desk-Top hands-free UE receiving

- a) The test signal to be used for the measurements shall be the artificial voice according to ITU-Recommendation P. 50 or a speech like test signal as described in ITU-T Recommendation P.501. The type of test signal used shall be stated in the test report. The test signal level shall be -16 dBm₀, measured at the digital reference point or the equivalent analogue point. The test signal level is averaged over the complete test signal sequence.
- b) The hands-free terminal is setup as described in subclause 5. If the HATS is used then it is freefield equalized as described in ITU-T Recommendation P.581 . The equalized output signal of each artificial ear is power-averaged on the total time of analysis; the 'right ' and 'left' signals are voltage-summed for each 1/3 octave band frequency band; these 1/3 octave band data are considered as the input signal to be used for calculations or measurements. Measurements shall be made at one third-octave intervals as given by the R.40 series of preferred numbers in ISO 3 [17] for frequencies from 100 Hz to 4 kHz inclusive. For the calculation the averaged measured level at each frequency band is referred to the averaged test signal level measured in each frequency band.
- c) The sensitivity is expressed in terms of dBPa/V.

7.4.5 Hand-Held hands-free UE sending

- a) The test signal to be used for the measurements shall be the artificial voice according to ITU-Recommendation P. 50 or a speech like test signal as described in ITU-T Recommendation P.501. The type of test signal used shall be stated in the test report. The spectrum of acoustic signal produced by the artificial mouth is calibrated under free field conditions at the MRP. The test signal level shall be $-4,7$ dBPa, measured at the MRP. The test signal level is averaged over the complete test signal sequence. The broadband signal level then is adjusted to $-28,7$ dBPa at the HFRP or the HATSHFRP (as defined in P. 581) and the spectrum is not altered.

The spectrum at the MRP and the actual level at the MRP (measured in third octaves) is used as reference to determine the sending sensitivity S_{mJ} .

- b) The hands-free terminal is setup as described in subclause 5.1.3.3. Measurements shall be made at one third-octave intervals as given by the R.40 series of preferred numbers in ISO 3 [17] for frequencies from 100 Hz to 4 kHz inclusive. For the calculation the averaged measured level at each frequency band is referred to the averaged test signal level measured in each frequency band.
- c) The sensitivity is expressed in terms of dBV/Pa.

7.4.6 Hand-Held hands-free UE receiving

- a) The test signal to be used for the measurements shall be the artificial voice according to ITU-Recommendation P. 50 or a speech like test signal as described in ITU-T Recommendation P.501. The type of test signal used shall be stated in the test report. The test signal level shall be -16 dBm₀, measured at the digital reference point or the equivalent analogue point. The test signal level is averaged over the complete test signal sequence.
- b) The hands-free terminal is setup as described in subclause 5.1.3.3. If the HATS is used then it is freefield equalized as described in ITU-T Recommendation P.581 . The equalized output signal of each artificial ear is power-averaged on the total time of analysis; the 'right ' and 'left' signals are voltage-summed for each 1/3 octave band frequency band; these 1/3 octave band data are considered as the input signal to be used for calculations or measurements. Measurements shall be made at one third-octave intervals as given by the R.40 series of preferred numbers in ISO 3 [17] for frequencies from 100 Hz to 4 kHz inclusive. For the calculation the averaged measured level at each frequency band is referred to the averaged test signal level measured in each frequency band.
- c) The sensitivity is expressed in terms of dBPa/V.

7.5 Sidetone characteristics

7.5.1 Connections with Handset UE

The test signal to be used for the measurements shall be the artificial voice according to ITU-Recommendation P. 50 or a speech like test signal as described in ITU-T Recommendation P.501. The type of test signal used shall be stated in

the test report. The spectrum of the acoustic signal produced by the artificial mouth is calibrated under free field conditions at the MRP. The test signal level shall be $-4,7$ dBPa, measured at the MRP. The test signal level is averaged over the complete test signal sequence.

Either the HATS method as described in subclause 5 or the LRGP method as described in subclause 5 with the exception noted in 7.5.1.1 shall be used.

7.5.1.1 Connections with Handset UE – LRGP method

The handset shall be positioned in the LRGP. The handset terminal is setup as described in subclause 5, with the following exception: The Type 3.2 Low Leak artificial ear, according to ITU-T Recommendation P. 57 shall be used.

The sidetone path loss L_{meST} as expressed in dB shall be calculated from each band of the 14 frequencies given in table 1 of ITU-T Recommendation P.79, bands 4 to 17. The STMR (in dB) shall be calculated from the formula B-4 of ITU-T Recommendation P.79, using $m = 0.225$ and the weighting factors in table B.2, unsealed condition, of ITU-T Recommendation P.79. No leakage correction (L_E) shall be applied.

7.5.1.2 Connections with Handset UE – HATS method

The handset is mounted in the HATS position (see ITU-T Recommendation P.64) and the application force shall be 13N on the artificial ear 3.3 or 3.4. The handset terminal is setup as described in subclause 5.

Where a user operated volume control is provided, the measurements shall be carried out at the nominal setting of the volume control. In addition the measurement is repeated at the maximum volume control setting.

Measurements shall be made at one twelfth-octave intervals as given by the R.40 series of preferred numbers in ISO 3 for frequencies from 100 Hz to 8 kHz inclusive. For the calculation the averaged measured level at each frequency band (ITU-T Recommendation P.79, table 4, bands 4 to 17) is referred to the averaged test signal level measured in each frequency band.

The Sidetone path loss (L_{meST}), as expressed in dB, and the SideTone Masking Rate (STMR) (in dB) shall be calculated from the formula 5-1 of ITU-T Recommendation P.79, using $m = 0.225$ and the weighting factors in table B.2, unsealed condition, of ITU-T Recommendation P.79. No leakage correction (L_E) shall be applied.

7.5.2 Headset UE

The test signal to be used for the measurements shall be the artificial voice according to ITU-Recommendation P. 50 or a speech like test signal as described in ITU-T Recommendation P.501. The type of test signal used shall be stated in the test report. The spectrum of the acoustic signal produced by the artificial mouth is calibrated under free field conditions at the MRP. The test signal level shall be $-4,7$ dBPa, measured at the MRP. The test signal level is averaged over the complete test signal sequence.

The artificial ear type is for further study.

The sidetone path loss L_{meST} as expressed in dB shall be calculated from each band of the 14 frequencies given in table 1 of ITU-T Recommendation P.79, bands 4 to 17. The STMR (in dB) shall be calculated from the formula B-4 of ITU-T Recommendation P.79 [16], using $m = 0.225$ and the weighting factors in Table B.2, unsealed condition, of ITU-T Recommendation P.79 [16]. No leakage correction (L_E) shall be applied.

7.5.3 Hands-free UE (all categories)

No requirement for other than echo control.

7.6 Stability loss

Where a user controlled volume control is provided it is set to maximum. **Handset UE:** The handset is placed on a hard plane surface with the transducers facing the surface.

Headset UE: for further study

Hands-free UE (all categories): no requirement other than echo loss.

A gain equivalent to the minimum stability margin is inserted in the loop between the go and return paths of the reference speech coder in the SS and any acoustic echo control is enabled.

A test signal according to ITU-T O.131 is injected into the loop at the analogue or digital input of the reference speech codec of the SS and the stability is measured. The test signal has a level of -10 dBm0 and a duration of 1 s.

No continuous audible oscillation shall be detected after the test signal is switched off.

7.7 Acoustic echo control

7.7.1 General

The echo loss (EL) presented by the GSM or 3G network at the POI should be at least 46 dB during single talk. This value takes into account the fact that UE is likely to be used in a wide range of noise environments.

7.7.2 Acoustic echo control in a Hands-free UE

TCLw:

The hands-free is setup in a room where it is intended to be used, eg. for an office type hands-free UE a typical 'office-type' room should be used; a vehicle-mounted hands-free UE should be tested in a vehicle or vehicle simulator, as specified by the UE manufacturer. [For reference on a suitable vehicle simulator see ETSI 0358 601 (TR101110) Digital Cellular Telecommunications System (Phase 2+) .] The ambient noise level shall be less than -70 dBPa(A). The attenuation from reference point input to reference point output shall be measured using a speech like test signal .

Before the actual test a training sequence consisting of 10 s artificial voice male and 10 s artificial voice female according to ITU-T Recommendation P.50 is altered.

Either a logarithmically spaced multi-sine or PN-sequence test signal shall be used.

When using a logarithmically spaced multi-sine test signal, it is defined as:

$$s(t) = \sum_i \left[\left[A + \mu_{AM} \cos(2\pi * f_{AM} * t) \right] * \cos(2\pi * f_{0i} * t) \right]$$

with

$$A = 0,5$$

$$f_{AM} = 4 \text{ Hz}, \mu_{AM} = 0,5$$

$$f_{0i} = 250\text{Hz} * 2^{(i/3)} \quad ; i=1..11$$

$$CF = 14\text{dB} \pm 1 \text{ dB} \quad (10 \text{ dB} + 4,26 \text{ dB due to 100\% AM modulation})$$

CF = Crest Factor = Peak to RMS ratio

The training sequence level shall be -16 dBm0 in order not to overload the codec. The test signal level shall be -10 dBm0. The TCLw is calculated according to ITU-T Recommendation G.122 [8], annex B, clause B.4 (trapezoidal rule). For the calculation the averaged measured echo level at each frequency band is referred to the averaged test signal level measured in each frequency band. The length of the test signal shall be at least one second (1,0 s).

Note:

Full scale of coder input signal corresponds to +3,14 dBm0 with sinusoidal signal, CF= 3dB. A test signal with a CF of maximum 15 dB can thus have a level of up to -8,86 dBm0 without overloading the codec. In order to get best dynamic range the signal amplitude should be as high as possible.

When using a PN-sequence, it should comply with ITU-T Recommendation P.501 with a length of 4096 points (for the 48 kHz sampling rate) and a crest factor of 6 dB. The duration of the test signal is 250ms. The test signal level is -3 dBm0. The low-crest factor is achieved by random-alternation of the phase between -180° and 180°.

The training sequence level shall be -16 dBm0 in order not to overload the codec. The TCLw is calculated according to ITU-T Recommendation G.122 [8], annex B, clause B.4 (trapezoidal rule). For the calculation the averaged measured echo level at each frequency band is referred to the averaged test signal level measured in each frequency band.

Care should be taken that the terminal under test considers the test signal as a speech-like signal.

7.7.3 Acoustic echo control in a handset UE

The handset is suspended in free air in such a way that the inherent mechanical coupling of the handset is not effected. The testing shall be made under real use environmental conditions; a typical 'office-type' room should be used. The ambient noise level shall be less than -64 dBPa(A). The attenuation from reference point input to reference point output shall be measured using the speech like test signal defined below.

Before the actual test a training sequence consisting of 10 s artificial voice male and 10 s artificial voice female according to ITU-T Recommendation P.50 is altered.

Either a logarithmically spaced multi-sine or PN-sequence test signal shall be used.

When using a logarithmically spaced multi-sine test signal, it is defined as:

$$s(t) = \sum_i \left[\left[A + \mu_{AM} \cos(2\pi * f_{AM} * t) \right] * \cos(2\pi * f_{0i} * t) \right]$$

with

$$A = 0,5$$

$$f_{AM} = 4 \text{ Hz}, \mu_{AM} = 0,5$$

$$f_{0i} = 250\text{Hz} * 2^{(i/3)} \quad ; i=1..11$$

$$CF = 14\text{dB} \pm 1 \text{ dB} \quad (10 \text{ dB} + 4,26 \text{ dB due to 100\% AM modulation})$$

CF = Crest Factor = Peak to RMS ratio

The training sequence level shall be -16 dBm0 in order not to overload the codec. The test signal level shall be -10 dBm0. The TCLw is calculated according to ITU-T Recommendation G.122 [8], annex B, clause B.4 (trapezoidal rule). For the calculation the averaged measured echo level at each frequency band is referred to the averaged test signal level measured in each frequency band. The length of the test signal shall be at least one second (1,0 s).

Note:

Full scale of coder input signal corresponds to $+3,14$ dBm0 with sinusoidal signal, CF= 3dB. A test signal with a CF of maximum 15 dB can thus have a level of up to $-8,86$ dBm0 without overloading the codec. In order to get best dynamic range the signal amplitude should be as high as possible.

When using a PN-sequence, it should comply with ITU-T Recommendation P.501 with a length of 4096 points (for the 48 kHz sampling rate) and a crest factor of 6 dB. The duration of the test signal is 250ms. The test signal level is -3 dB_{m0}. The low-crest factor is achieved by random-alternation of the phase between -180° and 180° .

The training sequence level shall be -16 dBm0 in order not to overload the codec. The TCLw is calculated according to ITU-T Recommendation G.122 [8], annex B, clause B.4 (trapezoidal rule). For the calculation the averaged measured echo level at each frequency band is referred to the averaged test signal level measured in each frequency band.

Care should be taken that the terminal under test considers the test signal as a speech-like signal.

7.7.4 Acoustic echo control in a headset UE

The headset is suspended in free air in such a way that the inherent mechanical coupling of the handset is not effected. The testing shall be made under real use environmental conditions; a typical 'office-type' room should be used. The ambient noise level shall be less than -64 dBPa(A). The attenuation from reference point input to reference point output shall be measured using the speech like test signal defined below.

Before the actual test a training sequence consisting of 10 s artificial voice male and 10 s artificial voice female according to ITU-T Recommendation P.50 is altered.

Either a logarithmically spaced multi-sine or PN-sequence test signal shall be used.

When using a logarithmically spaced multi-sine test signal, it is defined as:

$$s(t) = \sum_i \left[\left[A + \mu_{AM} \cos(2\pi * f_{AM} * t) \right] * \cos(2\pi * f_{0i} * t) \right]$$

with

$$A = 0,5$$

$$f_{AM} = 4 \text{ Hz}, \mu_{AM} = 0,5$$

$$f_{0i} = 250\text{Hz} * 2^{(i/3)} \quad ; i=1..11$$

$$CF = 14\text{dB} \pm 1 \text{ dB} \quad (10 \text{ dB} + 4,26 \text{ dB due to 100\% AM modulation})$$

CF = Crest Factor = Peak to RMS ratio

The training sequence level shall be -16 dBm0 in order not to overload the codec. The test signal level shall be -10 dBm0 . The TCLw is calculated according to ITU-T Recommendation G.122 [8], annex B, clause B.4 (trapezoidal rule). For the calculation the averaged measured echo level at each frequency band is referred to the averaged test signal level measured in each frequency band. The length of the test signal shall be at least one second (1,0 s).

Note:

Full scale of coder input signal corresponds to $+3,14 \text{ dBm0}$ with sinusoidal signal, $CF = 3\text{dB}$. A test signal with a CF of maximum 15 dB can thus have a level of up to $-8,86 \text{ dBm0}$ without overloading the codec. In order to get best dynamic range the signal amplitude should be as high as possible.

When using a PN-sequence, it should comply with ITU-T Recommendation P.501 with a length of 4096 points (for the 48 kHz sampling rate) and a crest factor of 6 dB. The duration of the test signal is 250ms. The test signal level is -3 dBm0 . The low-crest factor is achieved by random-alternation of the phase between -180° and 180° .

The training sequence level shall be -16 dBm0 in order not to overload the codec. The TCLw is calculated according to ITU-T Recommendation G.122 [8], annex B, clause B.4 (trapezoidal rule). For the calculation the averaged measured echo level at each frequency band is referred to the averaged test signal level measured in each frequency band.

Care should be taken that the terminal under test considers the test signal as a speech-like signal.

7.8 Distortion

7.8.1 Sending Distortion

The handset, headset, or hands-free UE is setup as described in clause 5.

A sine-wave signal with a frequency in the range 1 004 Hz to 1 025 Hz is applied at the MRP.

The level of this signal is adjusted until the output of the terminal is -10 dBm0 . The level of the signal at the MRP is then the ARL.

The test signal shall be applied at the following levels: 10, 5, 0, -5, -10, -15, -20, -25 dB relative to ARL. The test signals have to be applied in this sequence, i.e. from high levels down to low levels.

The ratio of the signal to total distortion power of the signal output of the SS shall be measured with the psophometric noise weighting (see ITU-T Recommendations G.712 and 0.132).

NOTE: It should be ensured that the test signal is treated by speech processing algorithms as a speech-like signal, and not a noise-like signal. Test signals with a time-stationary envelope may be treated by certain algorithms, e.g. noise suppression algorithms defined in 3GPP TS 06.77 R99[17], as a noise-like signal.

7.8.2 Receiving

The handset, headset, or hands-free UE is setup as described in clause 5.

A sine-wave signal with a frequency in the range 1 004 Hz to 1 025 Hz shall be applied at the signal input of the SS at the following levels: -45, -40, -35, -30, -25, -20, -15, -10, -5, 0 dBm0.

The ratio of the signal-to-total distortion power shall be measured at the ERP with the psophometric noise weighting (see ITU-T Recommendations G.712 and 0.132).

NOTE: It should be ensured that the test signal is treated by speech processing algorithms as a speech-like signal, and not a noise-like signal. Test signals with a time-stationary envelope may be treated by certain algorithms, e.g. noise suppression algorithms defined in 3GPP TS 06.77 R99[17], as a noise-like signal.

7.9 Ambient Noise Rejection

Handset and Headset UE:

NOTE: This section applies to terminals providing narrow- and wide-band telephony. However, the procedure for measuring ambient noise rejection is defined only over narrow-band frequency range. Thus the test method for ambient noise rejection is the same for either narrow- or wide-band telephony.

- a) A 1/2 inch pressure microphone is calibrated using a known sound source and mounted at the MRP, without the LRGP or HATS present. A frequency analyser is calibrated to enable the sound pressure levels at the microphone to be determined in 1/3rd Octave bands.
- b) Flood the room in which the measurement is to be made with a band limited (100 Hz to 8 kHz) pink noise to within ± 3 dB. The level at MRP shall be adjusted to 70 dB(A) (-24 dBPa(A)). The tolerance on this level is ± 1 dB. The resulting sound spectrum is P_{rn} dBPa, measured in 1/3rd Octave bands.

To ensure that the sound field is diffuse enough, the following apply:

The diffuse sound field is calibrated in the absence of any local obstacles. The averaged field shall be uniform to within ± 3 dB within a radius of 0,15 m of the MRP, when measured in one-third octave bands from 100 Hz to 3,15 kHz.

NOTE 1: The pressure intensity index, as defined in ISO 9614, may prove to be a suitable method for assessing the diffuse field.

NOTE 2: Where more than one loudspeaker is used to produce the desired sound field, the loudspeakers must be fed with non-coherent electrical signals to eliminate standing waves and other interference effects.

- c) Position the HATS or LRGP test head in the correct relative position to the MRP and mount the MS under test, according to clause 5.1.1. Recalibrate the 1/3rd Octave frequency analyser using a known voltage source to facilitate the analysis of the voltage V_{rn} , where V_{rn} is the voltage at the audio output of the SS due to the noise spectrum input.
- d) Set up a speech path between the MS and the System Simulator (SS).
- e) Determine, as a function of frequency, using the frequency analyser, in 1/3rd Octave bands (index j), the electrical output V_{jrn} , (expressed as dB rel . 1V) at the audio output of the SS for the applied acoustic pressure P_{jrn} (expressed as dB rel 1Pa) at the MRP. Since, the MS sending sensitivity is not defined above 3,4 kHz the measurement shall be cut off at 3,4 kHz. For the bands below 315 Hz, the noise level shall be referenced to the speech level at 315 Hz to yield the DELSM.

The room noise sensitivity is expressed as:- $S_{mjrn} = V_{jrn} \text{ (dBV)} - P_{jrn} \text{ (dBPa)}$.

The MS ambient noise send sensitivity has now been determined.

- f) The MS speech send sensitivity is now required. The required sensitivity is defined as the electrical output from the MS, measured at the audio output of the SS, as a function of the free field sound pressure at the MRP of the artificial mouth.

The test signal to be used for the measurements shall be the artificial voice according to ITU-Recommendation P.50 or a speech like test signal as described in ITU-T Recommendation P.501. The type of test signal used shall be stated in the test report. The 1/2 inch pressure microphone is calibrated using a known sound source. The frequency analyser is calibrated to measure in 1/3rd Octave bands. The spectrum of acoustic signal produced by the artificial mouth is calibrated under free field conditions at the MRP. The test signal level shall be -4,7 dBPa, measured at the MRP. The resulting sound spectrum is P_o dBPa, measured in 1/3rd Octave bands. The 1/3rd Octave frequency analyser should be re-calibrated, using a known voltage source, to facilitate the analysis of the voltage V_j . Where V_j is the voltage in each 1/3rd octave band at the audio output of the SS due to the test signal input. Set up a speech path between the MS and the SS. Determine the function of frequency, using the frequency analyser, and in 1/3rd Octave bands, the electrical output, V_j , (expressed as dB rel. 1V), at the audio output of the SS for the applied acoustic pressure, P_{j0} , (expressed as dB rel. 1Pa/V), at the MRP.

The speech sending sensitivity is expressed as:

$$Sm_{js} \text{ (dB)} = V_j \text{ (dBV)} - P_{j0} \text{ (dBPa)} \text{ dBrel. 1V/Pa.}$$

- g) The difference of the room noise sensitivity and the speech sending sensitivity DELSM (Δ_{jSM}) in each 1/3rd Octave band for the MS is determined as:

$$Sm_{jm} - Sm_{js} \text{ (dB)} \quad (\text{for } j = 1 \text{ to } 2, Sm_{js} = Sm_{3s}).$$

- h) The Ambient noise rejection ANR is calculated as the single figure value according to the following formula, the ANR shall be ≥ 0 dB.

$$ANR = -\frac{4}{5} \sum_{i=1}^{13} \Delta_{jSM} \cdot 10^{-0.0175W_{jsi}}$$

j = The index of third octave bands centered at frequencies from 200 Hz to 3 150 Hz inclusive.

W_{jsi} = The sending weighting factors from ITU-T Recommendation P.79 [16], table 1 for the j th 1/3rd Octave band centre frequency.

Hands-free UE (all categories):

No test method for hands-free operations.

8 Wideband telephony transmission performance test methods

8.1 Applicability

The test methods in this sub-clause shall apply when testing a UE which is used to provide narrow-band or wideband telephony, either as a stand-alone service, or as part of a multimedia service.

The application force used to apply the handset against the artificial ear shall be 8 ± 2 N. For the headset case the application of the headset shall comply with P.57.

8.2 Overall loss/loudness ratings

8.2.1 General

The SLR and RLR values for the GSM or 3G network apply up to the POI. However, the main determining factors are the characteristics of the UE, including the analogue to digital conversion (ADC) and digital to analogue conversion (DAC). In practice, it is convenient to specify loudness ratings to the Air Interface. For the normal case, where the GSM

or 3G network introduces no additional loss between the Air Interface and the POI, the loudness ratings to the PSTN boundary (POI) will be the same as the loudness ratings measured at the Air Interface.

8.2.2 Connections with handset UE

8.2.2.1 Sending Loudness Rating (SLR)

- a) The test signal to be used for the measurements shall be the artificial voice according to ITU-Recommendation P. 50 or a speech like test signal as described in ITU-T Recommendation P.501. The type of test signal used shall be stated in the test report. The spectrum of acoustic signal produced by the artificial mouth is calibrated under free field conditions at the MRP. The test signal level shall be $-4,7$ dBPa, measured at the MRP. The test signal level is averaged over the complete test signal sequence.
- b) The handset terminal is setup as described in subclause 5. The handset is mounted at the HATS according to ITU-T Recommendation P.64 [18]. The application force used to apply the handset against the artificial ear shall be within the range specified in ITU-T Recommendation P.64.

The sending sensitivity shall be calculated from each band of the 20 frequencies given in table G.1 of ITU-T Recommendation P.79 Annex A, bands 1 to 20. For the calculation the averaged measured level at the electrical reference point for each frequency band is referred to the averaged test signal level measured in each frequency band at the MRP.

- c) The sensitivity is expressed in terms of dBV/Pa and the SLR shall be calculated according to ITU-T Recommendation P.79, formula (A-23b), over bands 1 to 20, using $m = 0,175$ and the sending weighting factors from ITU-T Recommendation P.79 Annex A, table A2.

8.2.2.2 Receiving Loudness Rating (RLR)

- a) The test signal to be used for the measurements shall be the artificial voice according to ITU-Recommendation P. 50 or a speech like test signal as described in ITU-T Recommendation P.501. The type of test signal used shall be stated in the test report. The test signal level shall be -16 dBm0, measured at the digital reference point or the equivalent analogue point. The test signal level is averaged over the complete test signal sequence.
- b) The handset terminal is setup as described in subclause 5. The handset is mounted at the HATS according to ITU-T Recommendation P.64 [18]. The application force used to apply the handset against the artificial ear shall be within the range specified in ITU-T Recommendation P.64. The receiving sensitivity shall be calculated from each band of the 20 frequencies given in table A.2 of ITU-T Recommendation P.79 Annex A, bands 1 to 20. For the calculation, the averaged measured level at each frequency band is referred to the averaged test signal level measured in each frequency band.
- c) The sensitivity is expressed in terms of dBPa/V and the RLR shall be calculated according to ITU-T Recommendation P.79 [16], formula (A-23c), over bands 1 to 20, using $m = 0,175$ and the receiving weighting factors from table A.2 of ITU-T Recommendation P.79 Annex A [16].
- d) No leakage correction shall be applied.

8.2.3 Connections with Vehicle Mounted & Desktop Mounted hands-free UE

Vehicle mounted hands-free should be tested in the vehicle (for the totally integrated vehicle hands-free systems) or in a vehicle simulator, ref ETSI 0358 601 (TR101110) Digital Cellular Telecommunications System (Phase 2+) Characterization test methods and quality assessment for hands-free mobiles.

Free Field measurements for vehicle mounted hands-free are for further study.

8.2.3.1 Sending Loudness Rating (SLR)

- a) The test signal to be used for the measurements shall be the artificial voice according to ITU-Recommendation P. 50 or a speech like test signal as described in ITU-T Recommendation P.501. The type of test signal used shall be stated in the test report. The spectrum of acoustic signal produced by the artificial mouth is calibrated under free field conditions at the MRP. The test signal level shall be $-4,7$ dBPa, measured at the MRP. The test signal

level is averaged over the complete test signal sequence. The broadband signal level then is adjusted to $-28,7$ dBPa at the HFRP or the HATSHFRP (as defined in P.581) and the spectrum is not altered. The spectrum at the MRP and the actual level at the MRP (measured in third octaves) is used as reference to determine the sending sensitivity S_{mj} .

- b) The hands-free terminal is setup as described in subclause 5. The sending sensitivity shall be calculated from each band of the 20 frequencies given in table A.2 of ITU-T Recommendation P.79 Annex A , bands 1 to 20. For the calculation the averaged measured level at the electrical reference point for each frequency band is referred to the averaged test signal level measured in each frequency band at the MRP.
- c) The sensitivity is expressed in terms of dBV/Pa and the SLR shall be calculated according to ITU-T Recommendation P.79, formula (A-23b), over bands 1 to 20, using $m = 0,175$ and the sending weighting factors from ITU-T Recommendation P.79 Annex A, table A.2.

8.2.3.2 Receiving Loudness Rating (RLR)

- a) The test signal to be used for the measurements shall be the artificial voice according to ITU-Recommendation P. 50 or a speech like test signal as described in ITU-T Recommendation P.501. The type of test signal used shall be stated in the test report. The test signal level shall be -16 dBm0, measured at the digital reference point or the equivalent analogue point. The test signal level is averaged over the complete test signal sequence.
- b) The hands-free terminal is setup as described in subclause 5. If HATS is used then it is freefield equalized as described in ITU-T Recommendation P.581. The equalized output signal of each artificial ear is power-averaged on the total time of analysis; the 'right ' and 'left' signals are voltage-summed for each 1/3 octave band frequency band; these 1/3 octave band data are considered as the input signal to be used for calculations or measurements. The receiving sensitivity shall be calculated from each band of the 20 frequencies given in table A.2 of ITU-T Recommendation P.79 Annex A, bands 1 to 20.

For the calculation the averaged measured level at each frequency band is referred to the averaged test signal level measured in each frequency band.

- c) The sensitivity is expressed in terms of dBPa/V and the RLR shall be calculated according to ITU-T Recommendation P.79 [16], formula (A-23c), over bands 1 to 20, using $m = 0,175$ and the receiving weighting factors from table A.2 of ITU-T Recommendation P.79 Annex A.
- d) No leakage correction shall be applied. The hands-free correction as described in P.340 shall be applied. To compute Receiving loudness rating (RLR) for hands-free terminal (see also ITU-T Recommendation P.340), when using the combination of left and right ear signals from HATS the HFL_E has to be 8 dB, instead of 14 dB. For further information see ITU-T Recommendation P.581.

8.2.4 Connections with Handheld hands-free UE

8.2.4.1 Sending Loudness Rating (SLR)

- a) The test signal to be used for the measurements shall be the artificial voice according to ITU-Recommendation P. 50 or a speech like test signal as described in ITU-T Recommendation P.501. The type of test signal used shall be stated in the test report. The spectrum of acoustic signal produced by the artificial mouth is calibrated under free field conditions at the MRP. The test signal level shall be $-4,7$ dBPa, measured at the MRP. The test signal level is averaged over the complete test signal sequence. The broadband signal level then is adjusted to $-28,7$ dBPa at the HFRP or the HATSHFRP (as defined in P. 581) and the spectrum is not altered. The spectrum at the MRP and the actual level at the MRP (measured in third octaves) is used as reference to determine the sending sensitivity S_{mj} .
- b) The hands-free terminal is setup as described in subclause 5.1.3.3. The sending sensitivity shall be calculated from each band of the 20 frequencies given in table A.2 of ITU-T Recommendation P.79 Annex A, bands 1 to 20. For the calculation the averaged measured level at the electrical reference point for each frequency band is referred to the averaged test signal level measured in each frequency band at the MRP.
- c) The sensitivity is expressed in terms of dBV/Pa and the SLR shall be calculated according to ITU-T Recommendation P.79, formula (A-23b), over bands 1 to 20, using $m = 0,175$ and the sending weighting factors from ITU-T Recommendation P.79 Annex A, table A.2.

8.2.4.2 Receiving Loudness Rating (RLR)

- a) The test signal to be used for the measurements shall be the artificial voice according to ITU-Recommendation P. 50 or a speech like test signal as described in ITU-T Recommendation P.501. The type of test signal used shall be stated in the test report. The test signal level shall be -16 dBm₀, measured at the digital reference point or the equivalent analogue point. The test signal level is averaged over the complete test signal sequence.
- b) The hands-free terminal is setup as described in subclause 5.1.3.3. If HATS is used then it is freefield equalized as described in ITU-T Recommendation P.581. The equalized output signal of each artificial ear is power-averaged on the total time of analysis; the 'right' and 'left' signals are voltage-summed for each 1/3 octave band frequency band; these 1/3 octave band data are considered as the input signal to be used for calculations or measurements. The receiving sensitivity shall be calculated from each band of the 20 frequencies given in table A.2 of ITU-T Recommendation P.79 Annex A, bands 1 to 20.

For the calculation the averaged measured level at each frequency band is referred to the averaged test signal level measured in each frequency band.

- c) The sensitivity is expressed in terms of dBPa/V and the RLR shall be calculated according to ITU-T Recommendation P.79 [16], formula (A-23c), over bands 1 to 20, using $m = 0,175$ and the receiving weighting factors from table A.2 of ITU-T Recommendation P.79 Annex A.
- d) No leakage correction shall be applied. The hands-free correction as described in P.340 shall be applied. To compute the Receiving loudness rating (RLR) for hands-free terminals (see also ITU-T Recommendation P.340) when using the combination of left and right ear signals from HATS the HFL_E has to be 8 dB, instead of 14 dB. For further information see ITU-T Recommendation P.581.

8.2.5 Connections with headset UE

Same as for handset.

8.3 Idle channel noise (handset and headset UE)

8.3.1 Sending

The terminal should be configured to the test equipment as described in subclause 5.1.

The environment shall comply with the conditions described in subclause 6.1 for idle channel noise measurement.

For testing narrow-band functionality, the Psophometric noise level at the output of the SS is measured. The psophometric filter is described in ITU-T Recommendation O.41.

For testing wideband functionality, the A-weighted noise level at the output of the SS is measured. The A-weighting filter is described in IEC 60651.

A test signal may have to be intermittently applied to prevent "silent mode" operation of the MS. This is for further study.

8.3.2 Receiving

The terminal should be configured to the test equipment as described in subclause 5.1.

The environment shall comply with the conditions described in subclause 6.1.

A test signal may have to be intermittently applied to prevent "silent mode" operation of the MS. This is for further study.

For testing narrow-band or wideband functionality, the A-weighted level of the noise shall be measured at the ERP. The A-weighting filter is described IEC 60651 [12].

8.4 Sensitivity/frequency characteristics

8.4.1 Handset and headset UE sending

The headset case is similar to the handset one, except for the application force.

- a) The test signal to be used for the measurements shall be the artificial voice according to ITU-Recommendation P. 50 or a speech like test signal as described in ITU-T Recommendation P.501. The type of test signal used shall be stated in the test report. The spectrum of acoustic signal produced by the artificial mouth is calibrated under free field conditions at the MRP. The test signal level shall be $-4,7$ dBPa, measured at the MRP. The test signal level is averaged over the complete test signal sequence.
- b) The handset terminal is setup as described in subclause 5. The handset is mounted at the HATS according to ITU-T Recommendation P.64. The application force used to apply the handset against the artificial ear shall be within the range as specified in clause 8.1.

Measurements shall be made at one twelfth-octave intervals as given by the R.40 series of preferred numbers in ISO 3 [17] for frequencies from 100 Hz to 8 kHz inclusive. For the calculation the averaged measured level at the electrical reference point for each frequency band is referred to the averaged test signal level measured in each frequency band at the MRP.

- c) The sensitivity is expressed in terms of dBV/Pa.

8.4.2 Handset and headset UE receiving

The headset case is similar to the handset one, except for the application force.

- a) The test signal to be used for the measurements shall be the artificial voice according to ITU-Recommendation P. 50 or a speech like test signal as described in ITU-T Recommendation P.501. The type of test signal used shall be stated in the test report. The test signal level shall be -16 dBm₀, measured at the digital reference point or the equivalent analogue point. The test signal level is averaged over the complete test signal sequence.
- b) The handset terminal is setup as described in subclause 5. The handset is mounted at the HATS according to ITU-T Recommendation P.64. The application force used to apply the handset against the artificial ear shall be within the range as specified in clause 8.1.

Measurements shall be made at one twelfth-octave intervals as given by the R.40 series of preferred numbers in ISO 3 [17] for frequencies from 100 Hz to 8 kHz inclusive. For the calculation the averaged measured level at each frequency band is referred to the averaged test signal level measured in each frequency band.

- c) The sensitivity is expressed in terms of dBPa/V, referred to the ERP. Information about correction factors are available in ITU-T Recommendation P.57.

8.4.3 Vehicle Mounted & Desktop hands-free UE sending

- a) The test signal to be used for the measurements shall be the artificial voice according to ITU-Recommendation P. 50 or a speech like test signal as described in ITU-T Recommendation P.501. The type of test signal used shall be stated in the test report. The spectrum of acoustic signal produced by the artificial mouth is calibrated under free field conditions at the MRP. The test signal level shall be $-4,7$ dBPa, measured at the MRP. The test signal level is averaged over the complete test signal sequence. The broadband signal level then is adjusted to $-28,7$ dBPa at the HFRP or the HATSHFRP (as defined in P. 581) and the spectrum is not altered. The spectrum at the MRP and the actual level at the MRP (measured in third octaves) is used as reference to determine the sending sensitivity S_{mJ} .
- b) The hands-free terminal is setup as described in subclause 5. Measurements shall be made at one third-octave intervals as given by the R.40 series of preferred numbers in ISO 3 [17] for frequencies from 100 Hz to 8 kHz inclusive. For the calculation the averaged measured level at each frequency band is referred to the averaged test signal level measured in each frequency band.
- c) The sensitivity is expressed in terms of dBV/Pa.

8.4.4 Vehicle Mounted & Desktop hands-free UE receiving

- a) The test signal to be used for the measurements shall be the artificial voice according to ITU-Recommendation P. 50 or a speech like test signal as described in ITU-T Recommendation P.501. The type of test signal used shall be stated in the test report. The test signal level shall be -16 dBm₀, measured at the digital reference point or the equivalent analogue point. The test signal level is averaged over the complete test signal sequence.
- b) The hands-free terminal is setup as described in subclause 5. If the HATS is used then it is freefield equalized as described in ITU-T Recommendation P.581 . The equalized output signal of each artificial ear is power-averaged on the total time of analysis; the 'right ' and 'left' signals are voltage-summed for each 1/3 octave band frequency band; these 1/3 octave band data are considered as the input signal to be used for calculations or measurements. Measurements shall be made at one third-octave intervals as given by the R.40 series of preferred numbers in ISO 3 [17] for frequencies from 100 Hz to 8 kHz inclusive. For the calculation the averaged measured level at each frequency band is referred to the averaged test signal level measured in each frequency band.
- c) The sensitivity is expressed in terms of dBPa/V.

8.4.5 Hand-Held hands-free UE sending

- a) The test signal to be used for the measurements shall be the artificial voice according to ITU-Recommendation P. 50 or a speech like test signal as described in ITU-T Recommendation P.501. The type of test signal used shall be stated in the test report. The spectrum of acoustic signal produced by the artificial mouth is calibrated under free field conditions at the MRP. The test signal level shall be $-4,7$ dBPa, measured at the MRP. The test signal level is averaged over the complete test signal sequence. The broadband signal level is then adjusted to $-28,7$ dBPa at the HFRP or the HATS HFRP (as defined in ITU-T Recommendation P.581) and the spectrum is not altered. The spectrum at the MRP and the actual level at the MRP (measured in third octaves) is used as reference to determine the sending sensitivity S_{mJ} .
- b) The hands-free terminal is setup as described in subclause 5.1.3.3. Measurements shall be made at one third-octave intervals as given by the R.40 series of preferred numbers in ISO 3 [17] for frequencies from 100 Hz to 8 kHz inclusive. For the calculation the averaged measured level at each frequency band is referred to the averaged test signal level measured in each frequency band.
- c) The sensitivity is expressed in terms of dBV/Pa.

8.4.6 Hand-Held hands-free UE receiving

- a) The test signal to be used for the measurements shall be the artificial voice according to ITU-Recommendation P. 50 or a speech like test signal as described in ITU-T Recommendation P.501. The type of test signal used shall be stated in the test report. The test signal level shall be -16 dBm₀, measured at the digital reference point or the equivalent analogue point. The test signal level is averaged over the complete test signal sequence.
- b) The hands-free terminal is setup as described in subclause 5.1.3.3. If the HATS is used then it is freefield equalized as described in ITU-T Recommendation P.581 . The equalized output signal of each artificial ear is power-averaged on the total time of analysis; the 'right ' and 'left' signals are voltage-summed for each 1/3 octave band frequency band; these 1/3 octave band data are considered as the input signal to be used for calculations or measurements. Measurements shall be made at one third-octave intervals as given by the R.40 series of preferred numbers in ISO 3 [17] for frequencies from 100 Hz to 8 kHz inclusive. For the calculation the averaged measured level at each frequency band is referred to the averaged test signal level measured in each frequency band.
- c) The sensitivity is expressed in terms of dBPa/V.

8.5 Sidetone characteristics

8.5.1 Connections with Handset UE

The test signal to be used for the measurements shall be the artificial voice according to ITU-Recommendation P. 50 or a speech like test signal as described in ITU-T Recommendation P.501. The type of test signal used shall be stated in

the test report. The spectrum of the acoustic signal shall be produced by the HATS. The test signal level shall be -4,7 dBPa, measured at the MRP. The test signal level is averaged over the complete test signal sequence.

The handset is mounted in the HATS position (see ITU-T Recommendation P.64) and the application force shall be 13N on the artificial ear 3.3 or 3.4. The handset terminal is setup as described in subclause 5.

Where a user operated volume control is provided, the measurements shall be carried out at the nominal setting of the volume control. In addition the measurement is repeated at the maximum volume control setting.

Measurements shall be made at one twelfth-octave intervals as given by the R.40 series of preferred numbers in ISO 3 for frequencies from 100 Hz to 8 kHz inclusive. For the calculation the averaged measured level at each frequency band (ITU-T Recommendation P.79, table 4, bands 1 to 20) is referred to the averaged test signal level measured in each frequency band.

The sidetone path loss (L_{meST}), as expressed in dB, and the SideTone Masking Rate (STMR) (in dB) shall be calculated from the formula 5-1 of ITU-T Recommendation P.79, using $m = 0.225$ and the weighting factors in table B.2, unsealed condition, of ITU-T Recommendation P.79. No leakage correction (L_E) shall be applied.

8.5.2 Headset UE

The test signal to be used for the measurements shall be the artificial voice according to ITU-Recommendation P. 50 or a speech like test signal as described in ITU-T Recommendation P.501. The type of test signal used shall be stated in the test report. The spectrum of the acoustic signal produced by the artificial mouth is calibrated under free field conditions at the MRP. The test signal level shall be -4,7 dBPa, measured at the MRP. The test signal level is averaged over the complete test signal sequence.

The artificial ear type is for further study.

The sidetone path loss L_{meST} as expressed in dB shall be calculated from each band of the 20 frequencies given in table G.1 of ITU-T Recommendation P.79 Annex A, bands 1 to 20. The STMR (in dB) shall be calculated from the formula B-4 of ITU-T Recommendation P.79 [16], using $m = 0.225$ and the weighting factors in Table B.2, unsealed condition, of ITU-T Recommendation P.79 [16]. No leakage correction (L_E) shall be applied.

8.5.3 Hands-free UE (all categories)

No requirement for other than echo control.

8.5.4 Sidetone delay for handset or headset

The handset or the headset terminal is setup as described in clause 5.5.1. The handset is mounted in the HATS position (see ITU-T Recommendation P.64 [18]).

The test signal is a rectangular impulse which is digitally generated with an impulse width of 1/48000 second. This impulse is converted to an analog voltage with a bandwidth limitation to 22 kHz. The impulse may be repeated with sufficient time distance. To avoid adaptation of potential noise reduction algorithms, the repetition should not be periodic but with randomly varied time distance.

The peak voltage of the impulse at the artificial mouth corresponds to approximately 10 Pa when calculated with the mouth sensitivity at 1 kHz. However, the rectangular voltage impulse is applied to the artificial mouth without equalization of the mouth response.

The signal from the artificial mouth is acquired as absolute peak over time with an aperture of 0.21 ms (10/48000 seconds). The origin of the time axis is set to the start of the impulse at the electric input of the artificial mouth. A high pass filter may be applied to suppress low frequency noise. However, such a high pass filter must be applied to the signal from the artificial ear and to the trigger signal from the electric input to the artificial mouth at the same time.

Several curves acquired in the way described above may be averaged in order to reduce the influence of noise.

The following algorithm shall be used to obtain a value for the sidetone delay:

- a) The first relative maximum is searched in the first 2 ms, and the level and time of this peak is noted.

- b) Starting from the maximum investigated delay time (e.g. 200 ms or 500 ms) going downwards to 8 ms, the first local maximum in the curve is searched which has a level difference of more than 20 dB to the last preceding minimum. This is to define a kind of minimum S/N for the found delayed component. If such a maximum is found, the sidetone delay is defined as the time difference between the time of the maximum found in b and the time of the maximum found in a.
- c) If no maximum is found in step b, the first 8 ms are searched for the last occurring maximum which is higher in level as the one found in step a. If such a maximum is found, the sidetone delay is defined as the time difference between the time of the maximum found in c and the time of the maximum found in a.
- d) If no maximum is found neither in step b nor in step c, the sidetone delay is defined to be < 8 ms.

NOTE: In step b), if the signal to noise is enhanced by averaging, a lower value than 20 dB may be allowed for the minimum difference between the searched maximum peak level and the closest minimum preceding it on the time scale.

8.6 Stability loss

Where a user controlled volume control is provided it is set to maximum.

Handset UE: The handset is placed on a hard plane surface with the transducers facing the surface.

Headset UE: for further study

Hands-free UE (all categories): no requirement other than echo loss.

A gain equivalent to the minimum stability margin is inserted in the loop between the go and return paths of the reference speech coder in the SS and any acoustic echo control is enabled.

A test signal according to ITU-T O.131 is injected into the loop at the analogue or digital input of the reference speech codec of the SS and the stability is measured. The test signal has a level of -10 dBm0 and a duration of 1 s.

No continuous audible oscillation shall be detected after the test signal is switched off.

8.7 Acoustic echo control

8.7.1 General

The echo loss (EL) presented by the GSM or 3G network at the POI should be at least 46 dB during single talk. This value takes into account the fact that UE is likely to be used in a wide range of noise environments.

8.7.2 Acoustic echo control in a hands-free UE

TCLw:

The hands-free is setup in a room where it is intended to be used, eg. for an office type hands-free UE a typical 'office-type' room should be used; a vehicle-mounted hands-free UE should be tested in a vehicle or vehicle simulator, as specified by the UE manufacturer. [For reference on a suitable vehicle simulator see ETSI 0358 601 (TR101110) Digital Cellular Telecommunications System (Phase 2+).] The ambient noise level shall be less than -70 dBPa(A). The attenuation from reference point input to reference point output shall be measured using a speech like test signal.

Before the actual test a training sequence consisting of 10 s artificial voice male and 10 s artificial voice female according to ITU-T Recommendation P.50 is altered.

Either a logarithmically spaced multi-sine or PN-sequence test signal shall be used.

When using a logarithmically spaced multi-sine test signal, it is defined as:

$$s(t) = \sum_i \left[\left[A + \mu_{AM} \cos(2\pi * f_{AM}) \right] * \cos(2\pi * f_{oi}) \right]$$

with $A = 0,5$

$f_{AM} = 4 \text{ Hz}, \mu_{AM} = 0,5$

$f_{0i} = 250\text{Hz} * 2^{(i/3)} \quad ;i=1..11$

$CF = 14\text{dB} \pm 1 \text{ dB} \quad (10 \text{ dB} + 4,26 \text{ dB due to 100\% AM modulation})$

CF = Crest Factor = Peak to RMS ratio

The training sequence level shall be -16 dBm0 in order not to overload the codec. The test signal level shall be -10 dBm0 . The TCLw is calculated according to ITU-T Recommendation G.122 [8], annex B, clause B.4 (trapezoidal rule). For the calculation the averaged measured echo level at each frequency band is referred to the averaged test signal level measured in each frequency band. The length of the test signal shall be at least one second (1,0 s).

Note:

Full scale of coder input signal corresponds to $+3,14 \text{ dBm0}$ with sinusoidal signal, $CF = 3\text{dB}$. A test signal with a CF of maximum 15 dB can thus have a level of up to $-8,86 \text{ dBm0}$ without overloading the codec. In order to get best dynamic range the signal amplitude should be as high as possible.

When using a PN-sequence, it should comply with ITU-T Recommendation P.501 with a length of 4096 points (for the 48 kHz sampling rate) and a crest factor of 6 dB. The duration of the test signal is 250ms. The test signal level is -3 dBm0 . The low-crest factor is achieved by random-alternation of the phase between -180° and 180° .

The training sequence level shall be -16 dBm0 in order not to overload the codec. The TCLw is calculated according to ITU-T Recommendation G.122 [8], annex B, clause B.4 (trapezoidal rule). For the calculation the averaged measured echo level at each frequency band is referred to the averaged test signal level measured in each frequency band.

Care should be taken that the terminal under test considers the test signal as a speech-like signal.

8.7.3 Acoustic echo control in a handset UE

The handset is suspended in free air in such a way that the inherent mechanical coupling of the handset is not effected. The testing shall be made under real use environmental conditions; a typical 'office-type' room should be used. The ambient noise level shall be less than -64 dBPa(A) . The attenuation from reference point input to reference point output shall be measured using the speech like test signal defined below.

Before the actual test a training sequence consisting of 10 s artificial voice male and 10 s artificial voice female according to ITU-T Recommendation P.50 is altered.

Either a logarithmically spaced multi-sine or PN-sequence test signal shall be used.

When using a logarithmically spaced multi-sine test signal, it is defined as:

$$s(t) = \sum_i \left[\left[A + \mu_{AM} \cos(2\pi * f_{AM}) \right] * \cos(2\pi * f_{0i}) \right]$$

with $A = 0,5$

$f_{AM} = 4 \text{ Hz}, \mu_{AM} = 0,5$

$f_{0i} = 250\text{Hz} * 2^{(i/3)} \quad ;i=1..11$

$CF = 14\text{dB} \pm 1 \text{ dB} \quad (10 \text{ dB} + 4,26 \text{ dB due to 100\% AM modulation})$

CF = Crest Factor = Peak to RMS ratio

The training sequence level shall be -16 dBm0 in order not to overload the codec. The test signal level shall be -10 dBm0 . The TCLw is calculated according to ITU-T Recommendation G.122 [8], annex B, clause B.4 (trapezoidal rule). For the calculation the averaged measured echo level at each frequency band is referred to the averaged test signal level measured in each frequency band. The length of the test signal shall be at least one second (1,0 s).

Note:

Full scale of coder input signal corresponds to +3,14 dBm0 with sinusoidal signal, CF= 3dB. A test signal with a CF of maximum 15 dB can thus have a level of up to –8,86 dBm0 without overloading the codec. In order to get best dynamic range the signal amplitude should be as high as possible.

When using a PN-sequence, it should comply with ITU-T Recommendation P.501 with a length of 4096 points (for the 48 kHz sampling rate) and a crest factor of 6 dB. The duration of the test signal is 250ms. The test signal level is –3 dB_{m0}. The low-crest factor is achieved by random-alternation of the phase between -180° and 180°.

The training sequence level shall be –16 dBm0 in order not to overload the codec. The TCLw is calculated according to ITU-T Recommendation G.122 [8], annex B, clause B.4 (trapezoidal rule). For the calculation the averaged measured echo level at each frequency band is referred to the averaged test signal level measured in each frequency band.

Care should be taken that the terminal under test considers the test signal as a speech-like signal.

8.7.4 Acoustic echo control in a headset UE

The headset is suspended in free air in such a way that the inherent mechanical coupling of the handset is not effected. The testing shall be made under real use environmental conditions; a typical 'office-type' room should be used. The ambient noise level shall be less than –64 dBPa(A). The attenuation from reference point input to reference point output shall be measured using the speech like test signal defined below.

Before the actual test a training sequence consisting of 10 s artificial voice male and 10 s artificial voice female according to ITU-T Recommendation P.50 is altered.

Either a logarithmically spaced multi-sine or PN-sequence test signal shall be used.

When using a logarithmically spaced multi-sine test signal, it is defined as:

$$s(t) = \sum_i \left[\left[A + \mu_{AM} \cos(2\pi * f_{AM} * t) \right] * \cos(2\pi * f_{oi} * t) \right]$$

with

$$A = 0,5$$

$$f_{AM} = 4 \text{ Hz}, \mu_{AM} = 0,5$$

$$f_{oi} = 250\text{Hz} * 2^{(i/3)} \quad ; i=1..11$$

$$CF = 14\text{dB} \pm 1 \text{ dB} \quad (10 \text{ dB} + 4,26 \text{ dB due to 100\% AM modulation})$$

CF = Crest Factor = Peak to RMS ratio

The training sequence level shall be –16 dBm0 in order not to overload the codec. The test signal level shall be -10 dBm0. The TCLw is calculated according to ITU-T Recommendation G.122 [8], annex B, clause B.4 (trapezoidal rule). For the calculation the averaged measured echo level at each frequency band is referred to the averaged test signal level measured in each frequency band. The length of the test signal shall be at least one second (1,0 s).

Note:

Full scale of coder input signal corresponds to +3,14 dBm0 with sinusoidal signal, CF= 3dB. A test signal with a CF of maximum 15 dB can thus have a level of up to –8,86 dBm0 without overloading the codec. In order to get best dynamic range the signal amplitude should be as high as possible.

When using a PN-sequence, it should comply with ITU-T Recommendation P.501 with a length of 4096 points (for the 48 kHz sampling rate) and a crest factor of 6 dB. The duration of the test signal is 250ms. The test signal level is –3 dB_{m0}. The low-crest factor is achieved by random-alternation of the phase between -180° and 180°.

The training sequence level shall be –16 dBm0 in order not to overload the codec. The TCLw is calculated according to ITU-T Recommendation G.122 [8], annex B, clause B.4 (trapezoidal rule). For the calculation the averaged measured echo level at each frequency band is referred to the averaged test signal level measured in each frequency band.

Care should be taken that the terminal under test considers the test signal as a speech-like signal.

8.8 Distortion

8.8.1 Sending Distortion

The handset, headset, or hands-free UE is setup as described in clause 5.

The signal used is an activation signal followed by a sine-wave signal with frequencies specified in clause 6.8 of TS 26.131. The duration of the sine wave shall be less than 1 s. The sine wave signal level shall be calibrated to -4,7 dBPa at the MRP for all frequencies, except for the sine wave with frequency 1020 Hz which shall be applied at the following levels at the MRP: -20, -15, -10, -4,7, 0, +5 dBPa. The test signals have to be applied in this sequence, i.e. from high levels down to low levels.

The ratio of the signal to total distortion power of the signal output of the SS shall be measured with the psophometric noise weighting (see ITU-T Recommendations G.712, O.41 and O.132). The weighting function shall be applied to the total distortion component only (not to the signal component).

An artificial voice according to ITU-Recommendation P.50 or a speech like test signal as described in ITU-T Recommendation P.501 can be used for activation. Level of this activation signal will be -4,7 dBPa at the MRP.

NOTE 1: Depending on the type of codec the test signal used may need to be adapted. If a sine wave is not usable, an alternative test signal could be a band limited noise signal centered on the above frequencies.

NOTE 2: It should be ensured that the test signal is treated by speech processing algorithms as a speech-like signal, and not a noise-like signal. Test signals with a time-stationary envelope may be treated by certain algorithms, e.g. noise suppression algorithms defined in 3GPP TS 06.77 R99[17], as a noise-like signal.

NOTE 3: The psophometric filter shall be normalized (0 dB gain) at 800 Hz as specified in ITU-T O.41.

8.8.2 Receiving

The handset, headset, or hands-free UE is setup as described in clause 5.

The signal used is an activation signal followed by a sine-wave signal with frequencies specified in clause 6.8 of TS 26.131. An artificial voice according to ITU-Recommendation P.50 or a speech like test signal as described in ITU-T Recommendation P.501 can be used for activation. The signal level shall be -16 dBm0, except for the sine-wave signal with a frequency 1020 Hz that shall be applied at the signal input of the SS at the following levels: 0, -3, -10, -16, -20, -30, -40, -45 dBm0. The test signals have to be applied in this sequence, i.e. from high levels down to low levels.

The ratio of the signal-to-total distortion power shall be measured at the ERP with the psophometric noise weighting (see ITU-T Recommendations G.712, O.41 and O.132). The weighting function shall be applied to the total distortion component only (not to the signal component).

NOTE 1: It should be ensured that the test signal is treated by speech processing algorithms as a speech-like signal, and not a noise-like signal. Test signals with a time-stationary envelope may be treated by certain algorithms, e.g. noise suppression algorithms defined in 3GPP TS 06.77 R99[17], as a noise-like signal.

NOTE 2: The psophometric filter shall be normalized (0 dB gain) at 800 Hz as specified in ITU-T O.41.

8.9 Ambient Noise Rejection

Handset and Headset UE:

NOTE: This clause applies to terminals providing narrow- and wide-band telephony. However, the procedure for measuring ambient noise rejection is defined only over narrow-band frequency range. Thus the test method for ambient noise rejection is the same for either narrow- or wide-band telephony.

- a) A 1/2 inch pressure microphone is calibrated using a known sound source and mounted at the MRP, without the LRGP or HATS present. A frequency analyser is calibrated to enable the sound pressure levels at the microphone to be determined in 1/3rd Octave bands.

- b) Flood the room in which the measurement is to be made with a band limited (100 Hz to 8 kHz) pink noise to within ± 3 dB. The level at MRP shall be adjusted to 70 dB(A) (-24 dBPa(A)). The tolerance on this level is ± 1 dB. The resulting sound spectrum is P_m dBPa, measured in 1/3rd Octave bands. To ensure that the sound field is diffuse enough, the following apply: the diffuse sound field is calibrated in the absence of any local obstacles. The averaged field shall be uniform to within ± 3 dB within a radius of 0,15 m of the MRP, when measured in one-third octave bands from 100 Hz to 6,3 kHz.

NOTE 1: The pressure intensity index, as defined in ISO 9614, may prove to be a suitable method for assessing the diffuse field.

NOTE 2: Where more than one loudspeaker is used to produce the desired sound field, the loudspeakers must be fed with non-coherent electrical signals to eliminate standing waves and other interference effects.

- c) Position the HATS or LRGP test head in the correct relative position to the MRP and mount the MS under test, according to clause 5.1.1. Recalibrate the 1/3rd Octave frequency analyser using a known voltage source to facilitate the analysis of the voltage V_m , where V_m is the voltage at the audio output of the SS due to the noise spectrum input.
- d) Set up a speech path between the MS and the System Simulator (SS).
- e) Determine, as a function of frequency, using the frequency analyser, in 1/3rd Octave bands (index j), the electrical output V_{jm} , (expressed as dB rel. 1V) at the audio output of the SS for the applied acoustic pressure P_{jm} (expressed as dB rel 1Pa) at the MRP. Since, the MS sending sensitivity is not defined above 6,3 kHz the measurement shall be cut off at 6,3 kHz. For the bands below 315 Hz, the noise level shall be referenced to the speech level at 315 Hz to yield the DELSM. The room noise sensitivity is expressed as: $Sm_{jm} = V_{jm} \text{ (dBV)} - P_{jm} \text{ (dBPa)}$. The MS ambient noise send sensitivity has now been determined.
- f) The MS speech send sensitivity is now required. The required sensitivity is defined as the electrical output from the MS, measured at the audio output of the SS, as a function of the free field sound pressure at the MRP of the artificial mouth. The test signal to be used for the measurements shall be the artificial voice according to ITU-Recommendation P.50 or a speech like test signal as described in ITU-T Recommendation P.501. The type of test signal used shall be stated in the test report. The 1/2 inch pressure microphone is calibrated using a known sound source. The frequency analyser is calibrated to measure in 1/3rd Octave bands. The spectrum of acoustic signal produced by the artificial mouth is calibrated under free field conditions at the MRP. The test signal level shall be -4,7 dBPa, measured at the MRP. The resulting sound spectrum is P_o dBPa, measured in 1/3rd Octave bands. The 1/3rd Octave frequency analyser should be re-calibrated, using a known voltage source, to facilitate the analysis of the voltage V_j . Where V_j is the voltage in each 1/3rd octave band at the audio output of the SS due to the test signal input. Set up a speech path between the MS and the SS. Determine the function of frequency, using the frequency analyser, and in 1/3rd Octave bands, the electrical output, V_j , (expressed as dB rel. 1V), at the audio output of the SS for the applied acoustic pressure, P_{jo} , (expressed as dB rel. 1Pa/V), at the MRP. The speech sending sensitivity is expressed as:

$$Sm_{js} \text{ (dB)} = V_j \text{ (dBV)} - P_{jo} \text{ (dBPa)} \text{ dBrel. } 1\text{V/Pa.}$$

- g) The difference of the room noise sensitivity and the speech sending sensitivity DELSM (Δ_{jSM}) in each 1/3rd Octave band for the MS is determined as:

$$Sm_{jm} - Sm_{js} \text{ (dB)} \quad (\text{for } j = 1 \text{ to } 2, Sm_{js} = Sm_{3s}).$$

- h) The Ambient noise rejection ANR is calculated as the single figure value according to the following formula, the ANR shall be ≥ 0 dB.

$$ANR = -\frac{4}{5} \sum_{i=1}^{16} \Delta_{jSM} \cdot 10^{-0.0175W_{jsi}}$$

j = The index of third octave bands centered at frequencies from 200 Hz to 6 300 Hz inclusive.

W_{jsi} = The sending weighting factors from ITU-T Recommendation P.79 Annex G [16], table G.1 for the jth 1/3rd Octave band centre frequency.

Hands-free UE (all categories):

No test method for hands-free operations.

Annex A (informative): Change history

| TSG SA# | TSG doc | Spec | CR | Rev | Cat | Vers | New Vers | Subject |
|---------|-----------|--------|------|-----|-----|-------|----------|---|
| 08 | | | | | | | 3.0.0 | Approved |
| 09 | SP-000397 | 26.132 | 001 | | F | 3.0.0 | 3.1.0 | Handheld hands-free Test Setup |
| 11 | SP-010107 | 26.132 | 002 | 1 | F | 3.1.0 | 3.2.0 | Harmonisation of test methods for acoustics between 3GPP and GSM |
| 11 | | 26.132 | | | | 3.2.0 | 4.0.0 | Release 4 |
| 11 | SP-010107 | 26.132 | 003 | 1 | B | 4.0.0 | 5.0.0 | Compatibility with testing wideband telephony transmission performance |
| 13 | SP-010454 | 26.132 | 004 | | B | 5.0.0 | 5.1.0 | Extended scope of test signals for Ambient Noise Rejection |
| 13 | SP-010454 | 26.132 | 006 | | F | 5.0.0 | 5.1.0 | Restricted scope of ITU-T P.501 test signals for 3G acoustic tests |
| 13 | SP-010454 | 26.132 | 008 | | A | 5.0.0 | 5.1.0 | Bandwidth of test signals for acoustic testing |
| 15 | SP-020080 | 26.132 | 011 | 1 | A | 5.1.0 | 5.2.0 | Correction of references and editorial changes (wrong decimal separators) |
| 16 | SP-020435 | 26.132 | 016 | | F | 5.2.0 | 5.3.0 | Correction on ANR test for hands-free Ues |
| 21 | SP-030445 | 26.132 | 026 | | F | 5.3.0 | 5.4.0 | Loudness rating measurements at lower bit rates |
| 25 | SP-040649 | 26.132 | 028 | | C | 5.4.0 | 6.0.0 | Change of sending distortion test case |
| 35 | SP-070026 | 26.132 | 0030 | | F | 6.0.0 | 6.1.0 | Reference Update for ITU-T Recommendation P.57 'Artificial Ears' |
| 35 | SP-070026 | 26.132 | 0031 | 1 | F | 6.0.0 | 6.1.0 | Update of reference [16] to P.79-2001 Annex G |
| 35 | SP-070026 | 26.132 | 0032 | 1 | F | 6.0.0 | 6.1.0 | Distinction between narrow-band and wideband telephony in the frequency ranges and loudness rating and STMR weights, and in ANR calculation |
| 36 | | 26.132 | | | | 6.1.0 | 7.0.0 | Version for Release 7 |
| 38 | SP-070759 | 26.132 | 0034 | 2 | F | 7.0.0 | 7.1.0 | Changing the sidetone test to allow type 3.3 or 3.4 artificial ears |
| 42 | SP-080674 | 26.132 | 0035 | 1 | F | 7.1.0 | 7.2.0 | Correction to allow wideband testing for GSM terminals |
| 42 | SP-080685 | 26.132 | 0037 | 3 | C | 7.2.0 | 8.0.0 | Updated test methods for wideband terminal acoustics |
| 43 | SP-090015 | 26.132 | 0038 | | F | 8.0.0 | 8.1.0 | Clarification on Distortion with psophometric filter |
| 45 | SP-090568 | 26.132 | 0039 | 1 | F | 8.1.0 | 8.2.0 | Correction of STMR calculation |
| 66 | SP-140719 | 26.132 | 0075 | 1 | F | 8.2.0 | 8.3.0 | Correction of broadband signal level at the hands free reference point |

History

| Document history | | |
|-------------------------|--------------|-------------|
| V8.0.0 | January 2009 | Publication |
| V8.1.0 | April 2009 | Publication |
| V8.2.0 | October 2009 | Publication |
| V8.3.0 | January 2015 | Publication |
| | | |